

## Installation plan:

**PG 8581 – PG 8583**

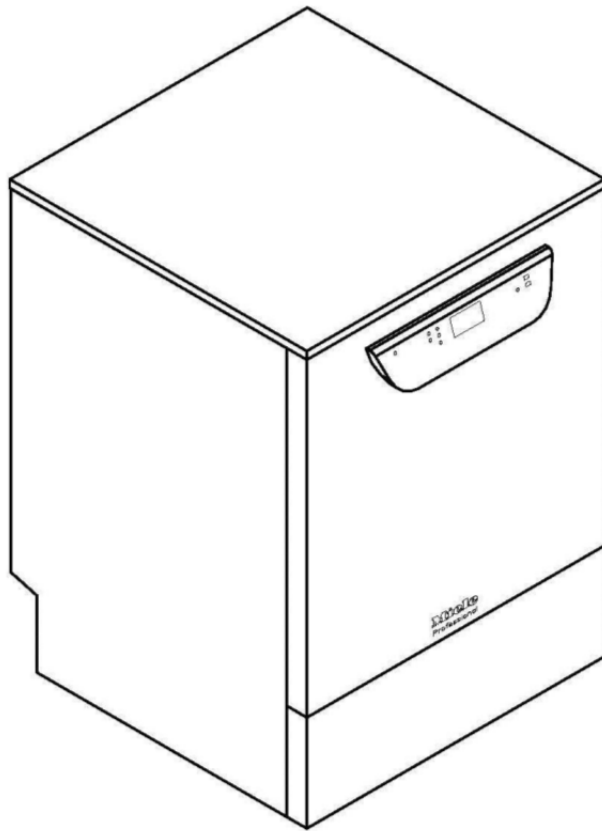

Mat. no.  
Version

10 390 400  
02

**GB, IE, AU, NZ**

Legend:











Circled, bold-type abbreviations:  
Connection required



Abbreviations surrounded by broken circle:  
Connection optional or required, depending on model

<b>EL</b>	Electrical connection <b>GB, IE</b>	Voltage (standard version) Connected load Fuse rating Connection cable, min. cross-sectional area Length of mains connection cable (H05(07)RN-F)	V/Hz kW A mm <sup>2</sup> m	AC 230 V/50 6.3 1 x 30 - 32 3 x 4 2.0
<b>EL</b>	Electrical connection <b>GB, IE</b>	Voltage (convertible) Connected load Fuse rating Connection cable, min. cross-sectional area Length of mains connection cable (H05(07)RN-F)	V/Hz kW A mm <sup>2</sup> m	3N AC 400/50 9.3 3 x 15/16 4 x 2.5 2.0
<b>EL</b>	Electrical connection <b>GB, IE</b>	Voltage (convertible) Connected load Fuse rating Connection cable, min. cross-sectional area Length of mains connection cable (H05(07)RN-F)	V/Hz kW A mm <sup>2</sup> m	AC 230 V/50 3.3 1 x 15 /16 3 x 1.5 2.0
<b>EL</b>	Electrical connection <b>AU, NZ</b>	Voltage (standard version) Connected load Fuse rating Connection cable, min. cross-sectional area Length of mains connection cable (H05(07)RN-F)	V/Hz kW A mm <sup>2</sup> m	3N AC 400/50 9.3 3 x 15/16 4 x 2.5 2.0
<b>EL</b>	Electrical connection <b>AU, NZ</b>	Voltage (convertible) Connected load Fuse rating Connection cable, min. cross-sectional area Length of mains connection cable (H05(07)RN-F)	V/Hz kW A mm <sup>2</sup> m	AC 230 V/50 6.3 1 x 30 - 32 3 x 4 2.0
<b>EL</b>	Electrical connection <b>AU, NZ</b>	Voltage (convertible) Connected load Fuse rating Connection cable, min. cross-sectional area Length of mains connection cable (H05(07)RN-F)	V/Hz kW A mm <sup>2</sup> m	AC 230 V/50 3.3 1 x 15 /16 3 x 1.5 2.0
		<p>We recommend connecting the washer-disinfector to the electrical supply via a plug and socket so that electrical safety checks, can be carried out easily. The plug and socket must be easily accessible after installation. A hard wired connection is possible. It must be made in accordance with local and national safety regulations:</p> <ul style="list-style-type: none"> <li>- IEE (IET) Wiring regulations BS 7671: 2008 (for GB and IE)</li> <li>- Australian / New Zealand Wiring Rules AS/NZS 3000</li> </ul> <p>Splash protection class IP21</p>		

	Equipotential bonding and protective earth conductor	There is a screw connection point at the back of the washer-disinfector, to which equipotential bonding can be connected if required.  Connect equipotential bonding and protective earth conductor!																																	
	External dispensing (optional)  (note machine model)	Connection for up to two dispensing units for liquid agents on the back panel.																																	
	Network/printer connection (optional)	Optional machine interface for transmission or process data output  Communication module (not supplied)  Ethernet module or RS232 module (install electrical sockets near machine if required)  Connections/installation must comply with: - IEC 60950 - AS/NZS 60950 (for AU and NZ)																																	
	Cold water	Two cold water connections are required for models with a steam condenser (DK). The second cold water hose can be connected using the Y-piece provided.  <table border="1" data-bbox="454 703 1402 1144"> <tr> <td>Maximum temperature</td> <td>°C</td> <td>20</td> </tr> <tr> <td rowspan="2">Max. water hardness</td> <td>mmol/l</td> <td>12.6</td> </tr> <tr> <td>°dH</td> <td>70</td> </tr> <tr> <td>Minimum flow pressure</td> <td>kPa</td> <td>200</td> </tr> <tr> <td>Minimum flow pressure with extended water intake</td> <td>kPa</td> <td>100</td> </tr> <tr> <td>Maximum pressure</td> <td>kPa</td> <td>1,000</td> </tr> <tr> <td>Flow rate</td> <td>l/min</td> <td>7.5</td> </tr> <tr> <td rowspan="2">On-site threaded union in accordance with (flat seal): - DIN 44991 - AS 3688 (for AU and NZ)</td> <td>Inch</td> <td>3/4" male thread</td> </tr> <tr> <td></td> <td></td> </tr> <tr> <td>Length of cold water inlet hose</td> <td>m</td> <td>Approx. 1.7</td> </tr> <tr> <td>Length of steam condenser hose</td> <td>m</td> <td>Approx. 1.7</td> </tr> </table> Connection to a drinking water supply in the UK requires the installation of an additional WRAS approved non-return device.  For Australia and New Zealand: This machine must be connected to the potable water supply via the non-return valve (dual check valve) supplied with the machine.			Maximum temperature	°C	20	Max. water hardness	mmol/l	12.6	°dH	70	Minimum flow pressure	kPa	200	Minimum flow pressure with extended water intake	kPa	100	Maximum pressure	kPa	1,000	Flow rate	l/min	7.5	On-site threaded union in accordance with (flat seal): - DIN 44991 - AS 3688 (for AU and NZ)	Inch	3/4" male thread			Length of cold water inlet hose	m	Approx. 1.7	Length of steam condenser hose	m	Approx. 1.7
Maximum temperature	°C	20																																	
Max. water hardness	mmol/l	12.6																																	
	°dH	70																																	
Minimum flow pressure	kPa	200																																	
Minimum flow pressure with extended water intake	kPa	100																																	
Maximum pressure	kPa	1,000																																	
Flow rate	l/min	7.5																																	
On-site threaded union in accordance with (flat seal): - DIN 44991 - AS 3688 (for AU and NZ)	Inch	3/4" male thread																																	
Length of cold water inlet hose	m	Approx. 1.7																																	
Length of steam condenser hose	m	Approx. 1.7																																	
	Hot water   (PG 8581 note machine version)	<table border="1" data-bbox="454 1294 1402 1682"> <tr> <td>Maximum temperature</td> <td>°C</td> <td>65</td> </tr> <tr> <td rowspan="2">Max. water hardness</td> <td>mmol/l</td> <td>12.6</td> </tr> <tr> <td>°dH</td> <td>70</td> </tr> <tr> <td>Minimum flow pressure</td> <td>kPa</td> <td>200</td> </tr> <tr> <td>Minimum flow pressure with extended water intake</td> <td>kPa</td> <td>40</td> </tr> <tr> <td>Maximum pressure</td> <td>kPa</td> <td>1,000</td> </tr> <tr> <td>Flow rate</td> <td>l/min</td> <td>7.5</td> </tr> <tr> <td rowspan="2">On-site threaded union in accordance with (flat seal): - DIN 44991 - AS 3688 (for AU and NZ)</td> <td>Inch</td> <td>3/4" male thread</td> </tr> <tr> <td></td> <td></td> </tr> <tr> <td>Length of hot water inlet hose</td> <td>m</td> <td>Approx. 1.7</td> </tr> </table> Connection to a drinking water supply in the UK requires the installation of an additional WRAS approved non-return device.  For Australia and New Zealand: This machine must be connected to the potable water supply via the non-return valve (dual check valve) supplied with the machine.			Maximum temperature	°C	65	Max. water hardness	mmol/l	12.6	°dH	70	Minimum flow pressure	kPa	200	Minimum flow pressure with extended water intake	kPa	40	Maximum pressure	kPa	1,000	Flow rate	l/min	7.5	On-site threaded union in accordance with (flat seal): - DIN 44991 - AS 3688 (for AU and NZ)	Inch	3/4" male thread			Length of hot water inlet hose	m	Approx. 1.7			
Maximum temperature	°C	65																																	
Max. water hardness	mmol/l	12.6																																	
	°dH	70																																	
Minimum flow pressure	kPa	200																																	
Minimum flow pressure with extended water intake	kPa	40																																	
Maximum pressure	kPa	1,000																																	
Flow rate	l/min	7.5																																	
On-site threaded union in accordance with (flat seal): - DIN 44991 - AS 3688 (for AU and NZ)	Inch	3/4" male thread																																	
Length of hot water inlet hose	m	Approx. 1.7																																	

  (PG 8581 note machine version)	Demineralised water	Maximum temperature	°C	65
		Minimum flow pressure (AD pressure resistant)	kPa	200
		Minimum flow pressure with extended water intake	kPa	30
		Maximum pressure (AD pressure resistant)	kPa	1,000
		Flow rate	l/min	7.5
		On-site threaded union in accordance with (flat seal): - DIN 44991 - AS 3688 (for AU and NZ)	Inch	3/4" male thread
		Length of demin. water inlet hose	m	Approx. 1.7
		For Great Britain and Ireland: Connection to a drinking water supply requires the installation of an additional WRAS approved non-return device.		
		For Australia and New Zealand: The demineralised water supply system must meet local and national regulations and include a backflow prevention device at first point on entry when connected to potable water.		
	<b>PG 8583 only:</b>	<b>Model with feed pump for unpressurised demineralised water (ADP)</b>		
		Minimum flow pressure (AD unpressurised)	kPa	8.5
		Maximum pressure (AD unpressurised)	kPa	60
		Machine connection nipple (outer dia. x l)	mm	6 x 30
		Hose from supply container to machine to be fitted on site		
	Waste water	Drainage temperature	°C	93
		Length of drain hose	m	Approx. 1.4
		Max. drain hose extension	m	Approx. 4.0
		Max. drain pump head height from base of machine	m	1.0
		Max. transient flow rate	l/min	16
		On-site sleeve for drain hose (dia. x length)	mm	22 x 30
		It is advisable to lay the drain hose in a curve min. 600 mm above floor level to the drainage point.		
Machine feet	Height-adjustable	mm	-0/+60	
	Machine foot diameter	mm	35	
	Machine foot socket	M	8	
Heat dissipation rate to installation site	Heat dissipation through heat radiation	kWh/h	0.35	
	Load heat dissipation on removal	kWh/h	0.40	
Machine data	Undercounter height	mm	820	
	Height incl. lid	mm	835	
	Width	mm	598	
	Depth	mm	598	
	Door height	mm	622	
	Net weight	kg	74	
	Floor load in operation	N	1,200	
	Min. access width, incl. transport pallet	mm	670	
	Min. access depth incl. transport pallet	mm	740	
Min. access height, incl. transport pallet	mm	920		
Installation conditions	Permissible ambient temperature	°C	5-40	
	Maximum relative humidity	%	80	
	Max. installation above sea level	m	1,500	
<p>It is essential to observe the installation instructions when installing the washer-disinfector.</p> <p>In order to reduce the risk of steam damage, the area around the washer-disinfector should be limited to furniture and fittings that are designed for use in commercial environments.</p> <p>Installation should only be performed by qualified fitters in accordance with valid regulations, relevant standards and health and safety codes! All rights reserved! Measurements in mm</p>				

