

Operating instructions

Washer-dryer

WT 945

To avoid the risk of accidents
or damage to the machine
it is **essential** to read
these instructions before it is
installed or used for the first time.



Contents

Caring for the environment	5
Disposal of the packing material	5
Disposal of your old appliance	5
Warning and Safety instructions	6
Description of the appliance	9
Features	9
Special programmes	9
Delay start.	9
Programme lock	9
Programmable functions.	9
Future updates (PC)	9
Control panel	10
Important control panel features	11
Programme selector	11
Additional option buttons	11
"Spin" button with indicator lamps	11
Washing and drying environmentally	12
Before using for the first time	13
WASHING	14
Programme overview	14
How to wash correctly	17
Care symbols - washing	17
Separate washing	19
Before washing	19
Select a programme	20
Selecting additional options for the wash programme	21
Delay start.	23
At the end of a programme	23
Adding and removing laundry	24
Programme cycle.	25

Adding detergent	27
Water softener	27
Washing with several components	27
Fabric conditioners / starch formulations	28
Fabric conditioners, texturisers and starch	28
Automatic dispensing of fabric conditioners, texturisers or liquid starch to laundry at the end of a programme	28
Adding fabric conditioner or liquid starch separately	28
Separate starching	28
DRYING	29
Tips on drying	29
Programme overview	30
Separate drying	32
Before drying	32
Programme selection	33
Additional options for the drying programmes	33
Delay start	34
At the end of a programme	34
WASHING AND DRYING	35
Washing and drying in a continuous sequence	35
After each washing or drying programme	36
Changing a programme sequence	38
Safety lock	39
Cleaning and care	40
Cleaning the machine	40
Cleaning the fluff filter and pump	42
Cleaning the filter in the water inlet	44

Contents

Problem solving guide	45
What to do if ... ?	45
The programme does not start.	46
A fault indicator lamp comes on but the wash programme continues as normal.	48
General problems or an unsatisfactory wash or drying result.	49
Opening the drum door in the event of a power failure	55
After sales service	56
Installation and connection	57
Front view.	57
Installation surface.	58
Installation	58
Removing the transit fitting	59
Levelling the machine	60
Screwing out and adjusting the feet.	60
Building under a continuous worktop / in a row of kitchen units	61
Connection to the water supply	62
Connection to the drainage system.	63
Electrical connection U.K.	64
Consumption data	66
Technical data	67
Programmable functions	70
High water level	70
Additional rinse for the COTTONS programme	71
Buzzer	72
Opening the door at high temperatures	73
Final residual moisture after drying	74

Disposal of the packing material

The transport and protective packing has been selected from materials which are environmentally friendly for disposal and can normally be recycled.

Ensure that any plastic wrappings, bags etc. are disposed safely and kept out of the reach of babies and young children. Danger of suffocation!

Rather than just throwing these materials away, please ensure they are offered for recycling.

Disposal of your old appliance

Old appliances may contain materials which can be reclaimed or recycled. Please contact your dealer, your local waste collection centre or scrap merchant about potential recycling schemes.

Ensure that the machine presents no danger to children while being stored for disposal. See the appropriate section in the Warning and safety instructions.

Warning and Safety instructions

Read the operating instructions before using this machine for the first time. They contain important information about the safety, installation, use and maintenance of the machine. This way you will avoid the risk of accidents and damage to the machine.

Keep these operating instructions in a safe place and ensure that new users are familiar with the content. Pass them on to any future owner of the machine.

Correct usage

■ This washer-dryer must only be used:

- to wash textiles which are declared by the manufacturer on the care label to be machine washable, as well as hand washable woollens.
- to dry textiles which have been washed in a water solution, marked on the manufacturer's wash care label as being suitable for tumble drying.

Any other applications may be dangerous. The manufacturer cannot be held responsible for damage caused by improper or incorrect use of the appliance.

■ Do not let small children play with the machine and its controls or operate it. Supervise its use by the elderly or infirm.

Technical safety

■ Before setting up the machine, check it for any externally visible damage.

Do not install or use a damaged machine.

■ Before connecting the machine, ensure that the connection data on the data plate (fusing, voltage and frequency) matches the mains electricity supply. If in any doubt, consult a qualified electrician.

■ The electrical safety of this machine can only be guaranteed when continuity is complete between the machine and an effective earthing system which complies with local and national safety regulations.

It is most important that this basic safety requirement is regularly tested by a qualified electrician.

The manufacturer cannot be held responsible for the consequences of an inadequate earthing system.

■ Do not connect the appliance to the mains electricity supply by an extension lead. Extension leads do not guarantee the required safety of the appliance (e.g. danger of overheating).

■ The machine is built in accordance with current safety requirements. Unauthorised repairs could result in unforeseen dangers for the user, for which the manufacturer cannot accept responsibility. Repairs should only be undertaken by a Miele approved technician.

■ The machine is only completely isolated from the electricity supply when:

- it is switched off at the wall socket and the plug is withdrawn, or
- it is switched off at the mains, or
- the mains fuse is withdrawn, or
- the screw-out fuse is removed in countries where this is applicable.

Warning and Safety instructions

■ This machine must only be connected to the on-site water supply using a new hose kit. Old hoses must not be re-used. Check the hose regularly for signs of wear and tear. Change in good time to avoid the risk of leaks and subsequent damage.

■ Faulty components must only be exchanged for Miele original spare parts. Only when these parts are fitted can the safety standards of the machine be guaranteed.

■ If the connection cable is damaged it must be replaced by a special Miele cable only.

■ In countries where there are areas which may be subject to infestation by cockroaches or other vermin, pay particular attention to keeping the appliance and its surroundings in a clean condition at all times. Any damage which may be caused by cockroaches or other vermin will not be covered by the appliance guarantee.

Use

■ This equipment is not designed for maritime use or for use in mobile installations such as caravans, aircraft etc. However it may be suitable for such usage subject to a risk assessment of the installation being carried out by a suitably qualified engineer.

■ **Take care, the metal cap is hot after drying.**

Open the door wide after the drying cycle. Do not touch the metal cap located on the inside of the door glass. It will still be hot and could cause a burn.

■ Do not install your machine in rooms where temperatures below freezing may occur. Frozen hoses may burst under pressure. The reliability of the electronic control unit may be impaired at temperatures below freezing point.

■ Before using the machine for the first time, check that the transit fitting at the rear of the machine has been removed (see section on "Installation"). During spinning, a transit fitting which is still in place may result in damage to both the machine and adjacent furniture or appliances.

■ Turn off the stopcock if the machine is to be left for any length of time (e.g. holiday), especially if there is no floor drain (gully) in the immediate vicinity.

■ **Flooding danger.**
If hooking the drain hose into a wash basin, check that the water can drain off quickly enough to prevent the sink from overflowing. Make sure the drain hose is secure, so that the force of the water flowing out of the hose does not dislodge it.

■ Take care to ensure that foreign objects (e.g. nails, pins, coins, paper clips) do not find their way into the machine with the laundry. These may damage components of the machine (e.g. suds container, drum), which in turn can result in damage to the laundry.

Warning and Safety instructions

For machines with a 'porthole' door, remember that the porthole glass will be hot when washing at very high temperatures. Do not let children touch it during a hot wash programme.

If the correct amount of detergent is dispensed, the machine should not need to be descaled. If, however, you do wish to descale the machine only use proprietary non-corrosive descaling agents and strictly observe the instructions on the packaging. If in doubt contact the Miele Customer Service Dept. or your Miele Dealer.

Never use solvent based cleaning agents in this machine, as this may result in damage to component parts and create toxic fumes. Such detergents also pose a fire and explosion hazard.

Textiles which have been pre-treated in solvent based cleaning agents must be thoroughly rinsed in clean water before being washed in the machine.

Only use dyes specified by the manufacturer as being suitable for use in a domestic washing machine. Always observe the manufacturer's instructions carefully.

Colour run and dye removers contain sulphur compounds which can cause damage such as corrosion. Do not use these products in this machine.

Always make sure the drum is stationary before reaching in to remove laundry. Reaching into a moving drum is extremely dangerous.

There is a danger of fire during drying with fabrics which:

- contain rubber, foam rubber or rubber like materials
- have been treated with inflammable cleaning agents
- have been splashed with hair lacquer, hair spray, nail varnish remover or similar substances
- which contain padding or fillings (e.g. pillows, jackets). If these were damaged, the filling could get out with the risk of igniting in the dryer.

Make sure that any dispensing balls etc. are removed from laundry before the drying programme. These dispensers can melt during the drying programme and cause damage to the machine and the laundry. Do not use liquid dispenser balls or similar if you are planning to wash and then dry in one continuous sequence.

Using accessories

Accessory parts may only be fitted when expressly approved by Miele. If other parts are used, guarantee, performance and product liability claims will be invalidated.

Disposal of your old machine

Disconnect and remove the mains plug from the socket. Render the plug useless. Cut off the cable directly behind the appliance to prevent misuse.

Description of the appliance

This washer-dryer can be used:

- **to wash separately**
with a max. load (depending on programme) of 5 kg;
- **to dry separately**
with a max. load (depending on programme) of 2.5 kg;
or
- **to wash and dry in a continuous sequence**
with a max. load (depending on programme) of 2.5 kg;

Features

Special programmes

- Programme for hand-washable fabrics (WOOLLENS )

Hand-washable or machine-washable wool or wool blend fabrics can be washed in the WOOLLENS  programme.

- Programme for small loads (Quick wash)

This is a Cottons programme for very lightly soiled fabrics.

- Rinse programme (Separate rinse)

Articles are only rinsed and spun in the machine.

Delay start

Delay start allows you to delay the start of a programme from 1 hour up to a maximum of 9 hours.

Programme lock

Electronic programme locking prevents the door from being opened or the programme cancelled during a wash programme. The electronic programme locking is automatically cancelled at the end of the programme.

Programmable functions

The programmable functions can be used to tailor washing programmes to suit your individual requirements. The selected function is displayed when in programming mode.

Future updates (PC)

The indicator or check lamp marked PC allows a service engineer to update your machine in future years.

When, for example, new programmes are developed or new fabrics are introduced, a service engineer will be able to modify existing programme cycles accordingly.

Important control panel features

Programme selector

The programme selector is used to set the

- basic wash programmes and temperatures
- and
- the drying programmes and temperatures.

Additional option buttons

Additional options can be added to the basic programme. Pressing the relevant button selects or de-selects the particular option. An additional option is selected if its indicator lamp is on. If the lamp does not come on, the function is not compatible with the programme you are trying to use it with. The indicator lamp will go out when the option button is released.

"Spin" button with indicator lamps

To change the spin speed press the "Spin" button.

It is not possible to select a spin speed higher than the permitted maximum spin for the basic wash programme. The indicator lamps show the setting selected.

Spinning at 400 - 1500 rpm

The spin can be set within this range for the

- final spin during a wash programme or
- for "Thermospin" during drying (see "DRYING - Programme selection" for information on the "Thermospin").

The final spin in a wash programme can also be deactivated:

- Press the "Spin" button until you reach

"Rinse hold"

The laundry is not spun and remains suspended in the final rinse water. This reduces creasing if the laundry is not going to be removed from the drum immediately after the end of the programme.

To continue the programme:

- with a final spin
press the "Spin" button until you reach the spin speed you want.
- without a final spin
Press the "Spin" button repeatedly until the *Without final spin* indicator lamp lights up.

Without final spin

The laundry is not spun after the final rinse but the water is drained away and the machine goes straight into the anti-crease stage.

Washing and drying environmentally

- Ideally load the maximum amount specified for the programme you are using.
This way energy and water consumption will be kept to a minimum.
- Use the QUICK WASH programme for small loads.
- Use the *Short wash* option for lightly soiled laundry.
- A main wash (programme without pre-wash) is sufficient for cleaning normally soiled laundry.
- Use the *Soak* option for heavily soiled laundry. The wash temperature can be reduced for the main wash when using the additional soak option.
- Use the additional option *Soak* instead of *Pre-wash* with heavily soiled laundry. If Soak is followed immediately by a main wash the same suds are used.
- Do not exceed the amounts of detergent which may be recommended by the manufacturer on the packaging.
- Reduce the amount of detergent with smaller loads (approx. 1/3 less than the amount recommended can be used when washing a half load).
- Load recognition can cause the duration of a programme to vary greatly. The main wash may be shortened and a rinse cycle omitted depending on the amount of laundry.
- Select a high spin speed for the wash programme, as well as for the Thermospin, if tumble drying the laundry afterwards. This saves time and energy.

Before using for the first time

Before using the machine for the first time ensure that it is correctly installed and connected. See the relevant section under "Installation".

Flushing out the drum

- Turn on the stopcock.
- Turn both programme selectors to the *Finish* position.
- Switch the machine on with the *I-ON / O-OFF* button.

Do not load any laundry.

- Add max. 1/4 of the amount of detergent recommended for a full load into Compartment **III** of the detergent dispenser.

- Turn the WASHING programme selector to the "COTTONS 60°C" position.

Important! This programme is required to prepare the machine for operation.

- Press the *Water plus* button.
- Press the "Spin" button repeatedly until the *Without final spin* indicator lamp comes on.
- Press the START button.

This will flush out any residues in the machine by the end of the programme.

Water hardness reminder

The amount of detergent required will depend on various factors, including water hardness. The dial in the detergent dispenser can be set as a water hardness reminder.

There is a yellow lever behind the detergent drawer facia panel.

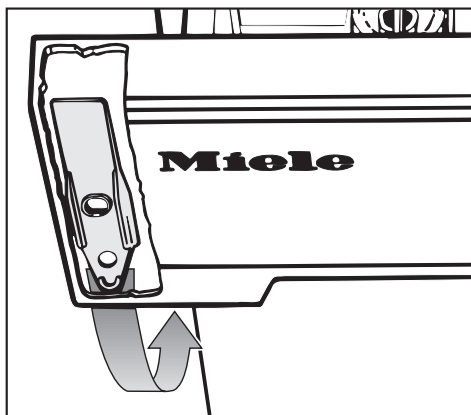

- Remove the lever.

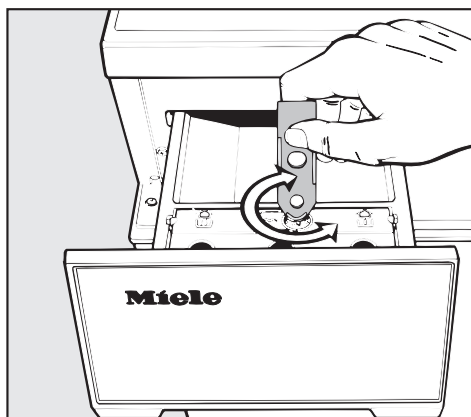



- Use it to turn the dial to the position which represents your water hardness level.



Your local water authority can advise on water hardness in your area.

WASHING

Programme overview

COTTONS 	
Fabric type	Cottons and linen fabrics, e.g. bed linen, table linen, towelling, jeans, underwear, T-shirts, nappies.
Additional options	Soak, Pre-wash, Water plus, Short.
Notes	<ul style="list-style-type: none"> – Only use the COTTONS 95°C programme for heavily soiled and incontinent laundry. – For heavily soiled laundry select the <i>Soak</i> or <i>Pre-wash</i> additional option. – For lightly soiled laundry select the <i>Short</i> option. – For dark coloured fabrics use a detergent for coloured fabrics, or liquid detergent.
Detergent	Powder detergent, detergent for coloured fabrics, liquid detergent.
Max. load	5 kg
Note for test institutes: Programme setting for the EN 50229 Standard <u>Cottons 60°C</u>	
MINIMUM IRON  	
Fabric type	White nylon (60°C), white polyester fabrics (50°C), coloured nylon, polyester, cotton and viscose fabrics with special finishes, acrylic, cotton fabrics, coloured polyester / cotton fabrics, (40°/30°C) minimum iron fabrics not washable at higher temperatures.
Additional options	Soak, Pre-wash, Water plus, Short.
Notes	<ul style="list-style-type: none"> – For heavily soiled laundry select the <i>Soak</i> or <i>Pre-wash</i> additional option. – For lightly soiled laundry select the <i>Short</i> option.
Detergent	Powder detergent, detergent for coloured fabrics, liquid detergent, detergent for delicates.
Max. load	2 kg

Programme overview

DELICATES 	
Fabric type	Acrylics, acetate and triacetate, 100% cotton easy care shirts and blouses. Curtains, specified machine-washable by the manufacturer.
Additional options	Soak, Pre-wash, Short
Notes	<ul style="list-style-type: none"> – Laundry remains relatively crease-free for easier ironing. – Dust in curtains usually makes using a programme with <i>Pre-wash advisable</i>. – For curtains made from delicate fabrics reduce the spin speed or select Without final spin.
Detergent	Detergent for delicates
Max. load	1 kg
WOOLLENS 	
Fabric type	Machine-washable or hand-washable wool or wool blend fabrics. Please note that hand-washable wool or wool blend fabrics will not shrink, stretch, matt or felt beyond the accepted tolerance of the item.
Notes	– For hand-washable garments made from delicate fabrics reduce the spin speed or select Without final spin.
Detergent	Liquid detergent for machine washable woollens
Max. load	1 kg
Quick wash 	
Fabric type	Very lightly soiled fabrics, which can be washed in the Cottons programme.
Additional option	Water plus
Notes	– Use less detergent (as for a half load).
Detergent	Powder detergent, detergent for coloured fabrics, liquid detergent.
Max. load	2.5 kg

WASHING



Programme overview

Starch	
Fabric type	Table cloths, napkins, overalls, aprons.
Notes	– The laundry should be washed but not treated with fabric conditioner.
Max. load	5 kg
Drain / Spin	
Notes	– Drain only: Select <i>Without final spin</i> .
Max. load	5 kg
Separate rinse	
Fabric type	Articles which have been washed by hand and only need to be rinsed and spun in the machine.
Notes	– Do not use for woollens.
Max. load	5 kg
Flushing out the drum	
Notes	– Fluff residues left in the drum after a Drying programme can be rinsed out. Important: there must be no items of laundry left in the drum! Always check that it is empty before selecting this option.

If "cold" is selected, the water is warmed to 24°C. This is to even out any fluctuations in the incoming water and helps the detergent to dissolve properly.







How to wash correctly

Care symbols - washing



Care symbols	Fabric types	Description of process	Programme: (select the appropriate temperature according to the temperature on the care label symbol)
 no bar	Cottons	Normal (maximum) machine action and normal spinning	Cottons, Minimum iron, Quick wash
 single bar	Synthetics	Reduced (medium) machine action and reduced spinning	Delicates
 broken bar	Woollens	Much reduced (minimum) machine action but with normal spinning	Hand Wash Woollens programmes.

How to wash correctly





Important - other care symbols

	Hand wash
	Do not wash
	Dry clean
	Do not dry clean
	Suitable for chlorine bleaching
	Do not use chlorine bleach





Tumble dry

	At normal temperature
	At low temperature
	Do not tumble dry

Ironing

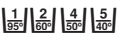
	Hot iron
	Medium hot iron
	Cool iron
	Do not iron

N.B. If you have any textiles with the older wash care labels, select a programme according to the label below:

	Cottons
	Minimum iron
	Delicates
	Woollens

Separate washing

Make sure that the DRYING programme selector is at the *Finish* position. Otherwise the drying programme set will follow on from the washing programme.

 Do not use solvent-based cleaning agents in this machine.

Before washing

1 Sort the laundry

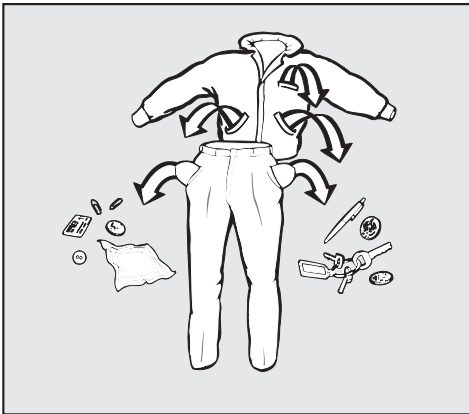

- Empty all pockets.

 Foreign objects (e.g. nails, coins, paper clips, etc.) can cause damage to garments and components in the machine.

- Stains etc. should be removed as soon as possible whilst still fresh. Spillages should be carefully dabbed off using a soft, colourfast cloth. Do not rub!

Badly soiled areas can be pre-treated with liquid detergent, stain removers etc. first, following the manufacturer's instructions. With particularly stubborn stains ask your dry cleaner for advice.

- Sort the laundry by colour and by care label symbol. Most garments have a textile care label in the collar or side seam. See the "Programme overview chart" for information on which programmes to use for different fabric types.

Dark textiles often contain excess dye and should be washed separately several times before being included in a mixed load.

- Curtains: Remove lead weights and strips or place in a laundry bag.
- Bras: Ensure any underwiring is securely sewn in. If not, remove it.
- Knitted garments, trousers and jeans, T-shirts and sweat shirts: Turn inside out, if recommended by the manufacturer.
- Close any zips, fasten hooks and eyes etc before washing.
- Fasten duvet covers etc. to prevent small items from being rolled up inside them.

Do not wash any items in this machine which are specified by the manufacturer as **non-machine washable** on the care label ( symbol).

How to wash correctly

2 Switch the machine on

- Press in the *I-ON/O-OFF* button.

3 Open the drum door

- Press the *Door* button and open the drum door.

4 Load the drum

- Unfold the laundry and load loosely in the drum. To achieve best results make up mixed loads consisting of both large and small items.

Do not exceed the maximum load for the programme selected. This uses the energy and water to the best advantage. Exceeding the maximum load will result in poorer wash results and an increased level of creasing.

5 Close the drum door

Make sure that no garments are caught between the drum door and seal.

6 Open the stopcock

Select a programme

7 Select the wash programme.

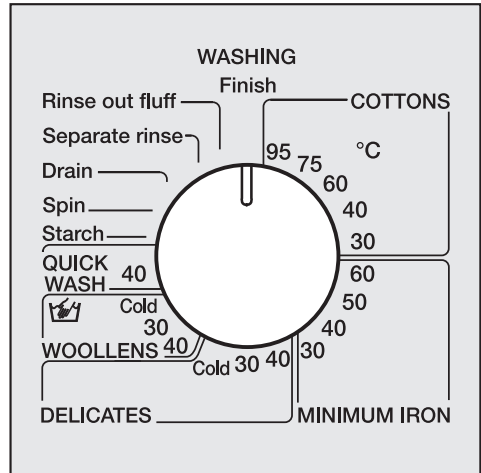

- Turn the programme selector to the required programme.

8 Select a spin speed.

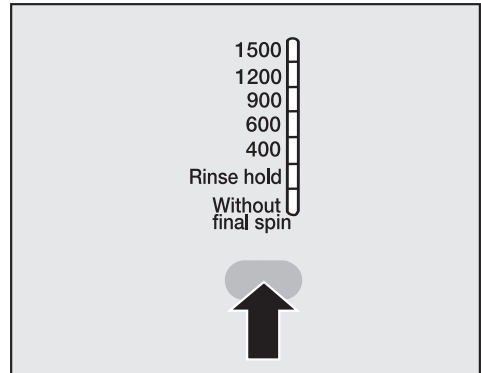

- Press the "Spin" button repeatedly until the indicator lamp for the spin speed you want comes on.

In some programmes, the maximum spin speed is limited. The machine will not allow a higher spin speed to be selected.

How to wash correctly

Selecting additional options for the wash programme

9 Select additional option(s)

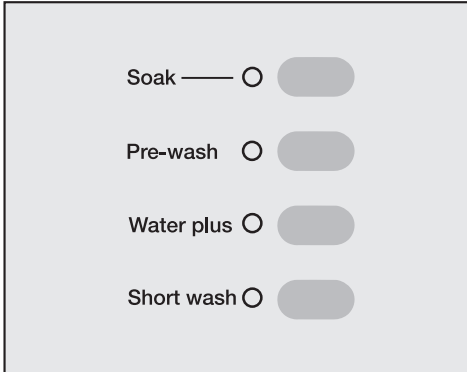

- Press the required additional option button(s).

Additional options which are not compatible with the basic programme cannot be selected. The indicator lamp will go out when the option button is released.

Soak

For heavily soiled and stained items with dried-on stains, or ones which can be bleached out, (e.g. blood, fats and oils, cocoa).

Duration of soak:
2 hours.



Detergent dispensing when selecting the soak option:

The amount to dispense will depend on which programme is to follow on from the soak process.

For programmes without a pre-wash:

- Add the total amount to compartment  or directly into the drum on top of the laundry.

For programmes with a pre-wash:

- Add 1/4 of the detergent for the soak and pre-wash into compartment , and 3/4 into compartment  for the main wash.

Pre-wash

For heavily soiled and stained items.

Water plus

The water level increases in all sections of the COTTONS / MINIMUM IRON and QUICK WASH 40°C programmes.

- for particularly delicate fabrics.
- if more water is required for dispensing the detergent.
- where a higher quality rinse is required.

Short

For lightly soiled items.

This shortens the programme running time. In the COTTONS and MINIMUM IRON programmes only two rinses are carried out with a higher water level.

How to wash correctly

10 Adding detergent





It is important to dispense the correct amount, because... . . .

. . . too little detergent results in:

- Laundry not being cleaned properly and with time it may become grey and hard to the touch.
- Greasy particles clinging to the laundry.
- Limescale deposits on the heater elements.



. . . too much detergent results in:

- Excessive foam, which causes a low level of agitation and poor wash, rinse and spin results.
- Higher water consumption because an extra rinse is automatically activated.
- A burden to the environment.

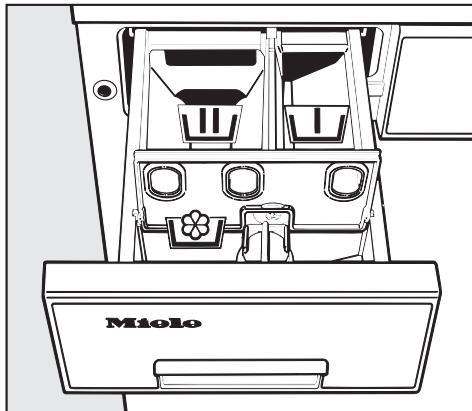
Add detergent for the pre-wash to compartment  and to compartment  for the main wash. If the capacity of compartment  is not sufficient (e.g. in water hardness area III), some of the main wash detergent can be added to compartment .



- Pull out the detergent drawer and place detergent in the compartments as follows:

-  = Pre-wash (if selected, 1/4 of the total amount recommended for the programme)
-  = Main wash including the Soak period if selected
-  = Fabric conditioner or liquid starch.

See "Detergent" section for further information.

Delay start

11 Select Delay start

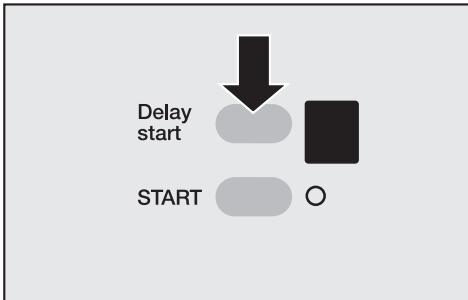

- Press the *Delay start* button repeatedly until the required delay start period shows up in the display (from 1 to 9 hours).

Press the "START" button. The chosen time will start to count down hour by hour. The programme will then start automatically.

To cancel "Delay start":

- Press the Delay start button once when 9 is showing in the display, or
- Switch the machine off with the *I-ON / O-OFF* button.

Memory function

If an additional option(s) is selected for a programme, and / or the spin speed is altered, the machine stores these changes in memory at the start of a programme.

When that particular programme is chosen again, the display will show the additional option(s) and / or spin speed which have been stored for that programme in the memory.

Exception: Delay start

12 Start the programme

The START indicator lamp will flash as soon as a programme can be started.

- Press the START button.
After the programme has started the START indicator lamp will light up constantly.

At the end of a programme

A buzzer will sound (see "Programmable functions") and the anti-crease / Finish light will come on.

After washing a full load

If you have washed a full load of laundry and you wish to dry the laundry in the dryer afterwards you will have to remove half the load. Carry out the drying procedure in two batches.

For further information on drying see section "After each washing or drying programme".

How to wash correctly

Adding and removing laundry

Laundry can be added or removed after the start of one of the following programmes:

- COTTONS
- MINIMUM IRON
- QUICK WASH 40°C
- Press the *Door* button in and hold it until the door springs open.
- Add or remove items.
- Close the door.

The programme will continue automatically.

The door cannot be opened, if:

- the suds temperature is above **70°C** (except when the programmable function "Opening the door at high temperatures" has been activated).
Warning: The water in the machine will be very hot and could cause burning or scalding.
- the additional function *Water plus* has been selected (because the water level will be too high).
- the safety lock has been activated.
- the programme has reached the *Final spin* stage.

The *locked* indicator lamp will come on if the *Door* button is pressed when the above conditions are present.

Programme cycle

This washing machine has fully electronic controls with automatic load recognition. This machine takes in the right amount of water required for the programme, depending on the amount of laundry and its absorbancy rate. This means that programme cycles and durations can vary.

The programme sequences outlined below are based on the basic programme with a full load. Additional options which can be selected, have not been taken into account.

The programme sequence indicator lamps show the stage the programme has reached.

COTTONS

Main wash

Water level: low

Wash rhythm: normal

Rinses

Water level: low

No of rinses: 3 or 4¹⁾

Spinning

Rinse and interim spin²⁾: yes

Final spin: yes

MINIMUM IRON

Main wash

Water level: low

Wash rhythm: normal

Rinses

Water level: medium

No of rinses: 3

Graduated rinsing³⁾: above 40°C

Spinning

Rinse and interim spin²⁾: yes

Final spin: yes

DELICATES

Main wash

Water level: high

Wash rhythm: Gentle action

Rinses

Water level: high

No of rinses: 3

Spinning

Rinse and interim spin²⁾: no

Final spin: yes

WOOLLENS

Main wash

Water level: low

Wash rhythm: Woollens

Rinses

Water level: low

No of rinses: 2

Spinning

Rinse and interim spin²⁾: yes

Final spin: yes

How to wash correctly

QUICK WASH

Main wash

Water level: low

Wash rhythm: normal

Rinses

Water level: medium

No of rinses: 2

Spinning

Rinse and interim spin²⁾: yes

Final spin: yes

Starch

Water level: low

Wash rhythm: normal

Final spin: yes

Separate rinse

Water level: high

No of rinses: 2

Final spin: yes

Special features in the programme sequences:

Anti-crease:

At the end of every programme, with the exception of the WOOLLENS programme, the anti-crease action switches on for a maximum of 30 minutes.

¹⁾ A fourth rinse takes place automatically when:

- there is too much foam in the drum
- if a spin speed of lower than 700 rpm has been selected.
- if *Without final spin* has been selected

²⁾ Rinse and interim spin:

There is a spin between the rinses.

³⁾ Graduated rinsing:

The suds are cooled at the end of the main wash cycle by water flowing in and being pumped away at intervals. This also helps minimise creasing.

Detergent

All modern detergents produced for automatic washing machines are suitable, including liquid, compact (concentrated), tablets and special application detergents.

Woollens and knitwear containing wool mixtures and hand-washable garments should be washed using a detergent specifically designed for washing woollens.

Instructions for use and recommended amounts for a full load are given on the detergent packaging.

The right amount to dispense will depend on the following:

- The soiling level of the laundry.

Lightly soiled

No visible dirt or stains. Possibly slight body odour.

Normally soiled

Visibly dirty and/or just a few slight stains.

Heavily soiled

Stains and soiling clearly visible.

- The quantity of laundry
- The water hardness level in the area
If you do not know the hardness level contact your local water authority who will be able to advise you.

Water hardness

Hardness range	Water hardness level	mmol/l	German scale °d
I	soft	0 - 1.3	0 - 7
II	medium	1.3 - 2.5	7 - 14
III	hard to very hard	above 2.5	above 14

Water softener

A water softener can be used to cut down on the use of detergents in water hardness ranges II - III. Dispense according to the amount specified on the packaging. First add detergent and then the water softener.

Use a quantity of detergent as for soft water.

Washing with several components

If you wash using several components (e.g. special application detergents), we recommend always dispensing the agents into compartment **III** in the following order:

1. Detergent
2. Water softener
3. Stain remover, e.g. Biotex

This way the agents are distributed more evenly.

Fabric conditioners / starch formulations

Fabric conditioners, texturisers and starch

Fabric conditioners make garments soft and fluffy to handle and help prevent static cling when tumble drying.

Texturisers are synthetic starch formulations, which stiffen items of laundry, e.g. shirts, tablecloths and bed linen.

Starch stiffens and gives body to items of laundry, e.g. shirts, tablecloths and bed linen.

- Dispense according to the amount specified on the packaging.

Automatic dispensing of fabric conditioners, texturisers or liquid starch to laundry at the end of a programme

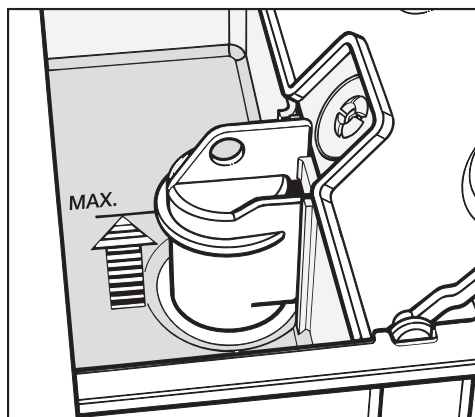

- Open the lid to compartment  and add conditioner, texturiser or starch. Do not exceed the maximum level mark.
- Close the lid and push the dispenser drawer back in.

The conditioner or liquid starch is automatically dispensed in the last rinse. At the end of the programme a small amount of water remains in compartment .

If starching frequently, clean the dispenser compartment and especially the siphon tube and conditioner channel. See "Cleaning the detergent dispenser drawer".

Adding fabric conditioner or liquid starch separately

- Add fabric conditioner or starch to compartment .
- Turn the WASHING programme selector to *Starch*.
- Select a spin speed.
- Press the START button.

Separate starching

- Prepare the starch solution in accordance with manufacturer's instructions on the packaging.
- Add the starch formulation to compartment .
- Turn the WASHING programme selector to *Starch*.
- Select a spin speed.
- Press the START button.

Tips on drying

- Before drying check the drying symbol on the wash care label.
- ☉ Dry at normal temperature
- ☾ Dry at low temperature (select the *Drying/low temp* additional option)
- ☒ Do not tumble dry

If there is no symbol, dry at your own risk applying the following principles:

- Cottons and minimum iron items should be dried using the appropriate programme.
- Delicate fabrics, e.g. acrylics, should be dried at a low temperature (select the *Drying/low temp* additional option).

The following fabrics should not be tumble dried:

- Woollens and wool blends these fabrics tend to become matted and shrink.
- Items filled with down the fine fabric interior tends to shrink, depending on the quality involved.
- Pure linen should only be machine dried if specified as suitable by the manufacturer on the wash care label, as the surface of the fabric may otherwise tend to roughen.

Woven and loopknit materials (e.g. T-Shirts, knitted garments) tend to shrink to varying extents depending on their quality. Therefore: to prevent further shrinkage do not over-dry these textiles. When purchasing these garments it is advisable to take their shrinkage properties into account.

Starched laundry can be dried in the tumble dryer. To achieve the usual finish, double the amount of starch should be used.

Fabrics which crease easily should only be given a short period in the dryer.

Minimum iron shirts in 100% cotton may crease during tumble drying depending on the quality of the weave. Use a short programme with a low setting. In extreme cases do not tumble dry these garments, but dry them on a hanger.

Minimum iron fabrics tend to crease more, the greater the load. This is particularly the case with delicate fabrics. Reduce the load.

New dark coloured garments should be dried separately from light coloured garments to avoid the danger of colours running.

DRYING

Programme overview

COTTONS	
Extra dry	
Fabric type	Multi-layered fabrics, which are thoroughly dried in the <i>Normal</i> programme.
Additional options	Thermospin max. 1500 rpm, Drying / Low temp.
Note	– Do not dry jerseywear in the <i>Extra dry</i> programme (tendency to shrink)
Max. load	2.5 kg
Normal	
Fabric type	Single and multi-layered fabrics, e.g. mixed load of cotton fabrics (e.g. towelling, jerseywear).
Additional options	Thermospin max. 1500 rpm, Drying / Low temp.
Max. load	2.5 kg
Note for test institutes: Programme setting for the EN 50229 Standard: COTTONS Normal	
Hand iron	
Fabric type	Cotton or linen fabrics (e.g. table linen, bed linen, starched laundry etc.).
Additional options	Thermospin max. 1500 rpm, Drying / Low temp.
Max. load	2.5 kg
Machine iron	
Fabric type	Cotton or linen fabrics, including starched laundry for machine ironing.
Additional options	Thermospin max. 1500 rpm, Drying / Low temp.
Note	– The laundry should be rolled up before ironing to prevent it from drying out.
Max. load	2.5 kg

Programme overview

MINIMUM IRON	
Normal plus	
Fabric type	Minimum iron items which are made of synthetic or blended fabrics (e.g. pullovers,, dresses, trousers) which are not dried adequately in the <i>Normal programme</i> .
Additional options	Thermospin max. 900 rpm, Drying / Low temp.
Note	– Spin fabrics for approx. 30 seconds before drying.
Max. load	1 kg
Normal	
Fabric type	Minimum iron shirts, table cloths etc. made of mixed fibres, e.g. cottons / synthetics.
Additional options	Thermospin max. 900 rpm, Drying / Low temp.
Max. load	1 kg
Hand iron	
Fabric type	Minimum iron shirts, table cloths etc. made of mixed fibres, e.g. cottons / synthetics, which are still to be hand ironed.
Additional options	Thermospin max. 900 rpm, Drying / Low temp.
Max. load	1 kg

TIMED DRYING 20 min / 30 min / 40 min / 60 min	
Do not select the longest drying time to start with. Check by experimenting, how long it takes to reach the level of drying you require.	
Fabric type	Multi-layered or padded items, which because of their composition will take varying times to dry. Items which need extra drying.
Additional options	Drying / Low temp.
Note	– When drying minimum iron fabrics: always select the Drying / Low temp. option.
Max. load	1 - 2.5 kg (depending on type of fabric)

DRYING

Separate drying

The separate drying programme must be used if the load in the wash programme is greater than the maximum load permitted for drying, or if you only want to dry part of the load that was washed.

Make sure that the WASHING programme selector is at the *Finish* position. Otherwise the washing programme will begin before the drying programme.

Before drying

1 Preparing the laundry

- Sort the laundry according to type of fibre / weave and the residual moisture content. This will help towards achieving an even drying result.

2 Switch the machine on

- Press in the *I-ON/O-OFF* button.

3 Open the drum door

- Press the *Door* button and open the drum door.

4 Load the drum

- Unfold the laundry and load loosely in the drum.

Maximum load:

Cottons	2.5 kg
Minimum iron	1.0 kg
Timed drying	2.5 kg

Make sure you have removed any detergent dispensing aids, e.g. plastic dispenser balls, before drying. These dispensers can melt during the drying programme and cause damage to the machine and the laundry.

Do not overload the drum. Overloading can cause unnecessary wear and tear to the laundry and give a disappointing drying result.

5 Close the drum door

Make sure that no garments are caught between the drum door and seal.

6 Open the stopcock

Programme selection

7 Select a drying programme

The programmes are described in the "Drying programme charts".

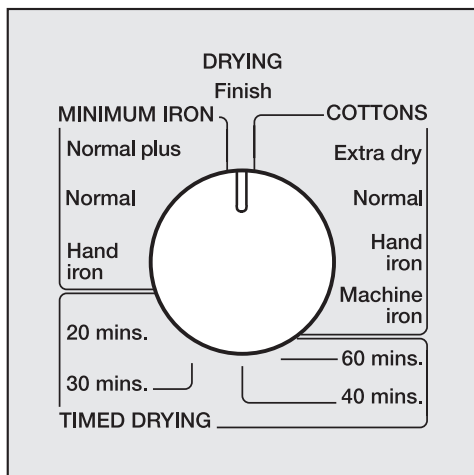

- Turn the programme selector to the required drying programme.
- For minimum iron fabrics which are being dried in the TIMED DRYING programme, you should always select the *Drying/ Low temp.* additional option.

The sensor drying programmes for COTTONS and MINIMUM IRON include a thermospin process. This process uses heat during a pre-tumbling spin to break the bond between the water and the clothes being dried. This reduces drying times and the amount of energy required for drying (one of the spin speed indicator lamps will light up).

Exception: The thermospin will not be carried out if the additional function *Drying/Low temp.* has been selected.

Additional options for the drying programmes

8 Select an additional option

"Thermospin"

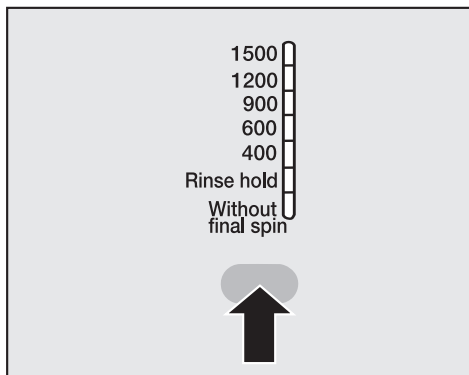

- Press the "Spin" button repeatedly until the indicator lamp for the spin speed you want for the thermospin comes on.

Exception: The thermospin will not be carried out if *TIMED DRYING* has been selected.

Drying / Low temp.

The temperature is reduced during the drying programme.

- This is suitable for particularly sensitive fabrics (care symbol ☐) e.g. acrylics.

The additional option *Drying/Low temp.* can be selected for any programme where it is required.

The thermospin will not take place.

DRYING

Delay start

9 Select Delay start

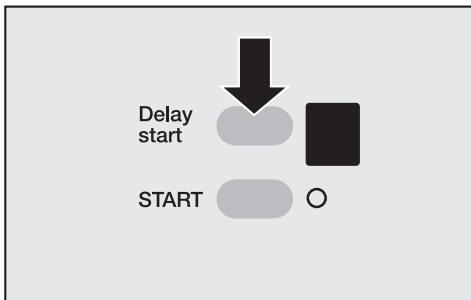

- Press the *Delay start* button repeatedly until the required delay start period shows up in the display (from 1 to 9 hours).

Press the "START" button. The chosen time will start to count down hour by hour. The programme will then start automatically.

To cancel "Delay start":

- Press the *Delay start* button once when 9 is showing in the display, or
- Switch the appliance off using the *I-ON/O-OFF* button.

Memory function

If an additional option(s) is selected for a programme, and / or the spin speed is altered, the machine stores these changes in memory at the start of a programme.

When that particular programme is chosen again, the display will show the additional option(s) and / or spin speed which have been stored for that programme in the memory.

Exception: Delay start

10 Start the programme

The START indicator lamp will flash as soon as a programme can be started.

- Press the START button.
After the programme has started the START indicator lamp will light up constantly.

The door cannot be opened if the temperature is higher than 70°C. If this is the case the *locked* indicator light will flash when the *Door* button is pressed.

Exception: when the programmable function "Opening the door at high temperatures" has been activated.

At the end of a programme

When the drying programme has finished the buzzer will sound (see "Programmable functions") and the *Anti-crease / finish sequence indicator lamp* will come on.

- Remove the laundry.

If you want to dry a further load:

- First switch the machine off and then on again with the *I-ON/O-OFF* button.
- Proceed as described before in this section.

After drying

For further information on drying see section "After each washing or drying programme".

Washing and drying in a continuous sequence

Where the amount of laundry to be washed and dried in one programme does not exceed the maximum weight permitted for the drying programme, washing and drying in one continuous sequence is recommended.

It is essential to read both sections "Separate washing" and "Separate drying" first.

1 Sort the laundry

2 Switch the machine on

3 Open the drum door

4 Load the drum

Maximum loads:

Cottons	2.5 kg
Minimum iron	1.0 kg
Quick wash	1.0 kg
Spin	2.5 kg

Do not use detergent dispensing aids, e.g. plastic dispenser balls, for washing followed immediately by the drying programme. These dispensers can melt during the drying programme and cause damage to the machine and the laundry.

5 Close the drum door

6 Open the stopcock

7 Add detergent

Use approximately 1/3 less detergent than is recommended by the manufacturer on the packaging.

8 Select the programme.

- Turn the WASHING programme selector to the required programme.
- Press the "Spin" button repeatedly until the indicator lamp for the spin speed you want comes on.
- Select any additional options that you require for the washing programme.

9 Select a drying programme

- Turn the DRYING programme selector to the required drying programme.

The Thermospin will automatically be carried out using the same spin speed as used in the wash programme.

The Thermospin will not be carried out if:

- you have selected a TIMED DRYING programme;
- the additional option *Drying/Low temp* has been selected.

- If required, select the additional option *Drying/Low temp*.

10 If required, select a "Delay start" period.

11 Start the programme

- Press the START button.

After each washing or drying programme

At the end of a programme

- A buzzer will sound (see "Programmable functions") and the Anti crease / Finish light will come on. Press the *Door button* and open the drum door wide.

 **Take care, the metal cap is hot after drying. Do not touch the metal cap located on the inside of the door glass. Danger of burning!**

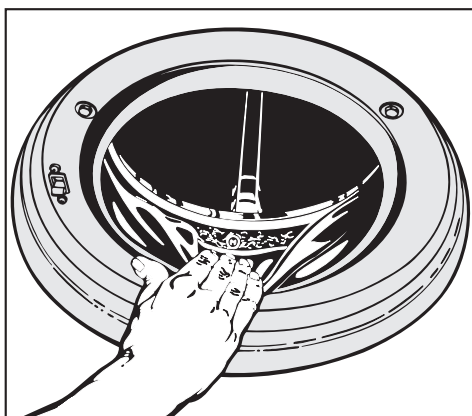

- Remove the laundry.
- Check the folds in the door seal for any small articles, e.g. buttons. Remove any fluff from drying from around the door seal.

Check that all items have been removed from the drum. Items left behind could colour run, shrink or be damaged in the next washing or drying programme.

- Close the door. Otherwise there is the danger of objects being placed inadvertently in the drum. If these remained unnoticed and were washed in the next load, they could damage the laundry.
- Press in the *I-ON/O-OFF* button to switch the machine off.

After each washing or drying programme

After drying

"Rinse out fluff" programme

The fluff which occurs during drying can collect in the drum and also in the suds container. It is best to rinse out this fluff before the machine is used again, so that it cannot be deposited on the next load of laundry.

The *Rinse out fluff* programme must not be used for rinsing items of laundry. Make sure that there are no items of laundry in the drum before starting this programme.

- Switch the machine on.
- Turn the DRYING programme selector to the *Finish* position.
- Turn the WASHING programme selector to the *Rinse out fluff* programme.
- Press the START button.

The fluff will be rinsed out in a few minutes.

- Remove any fluff remaining from around the door seal.
- Switch the machine off.

Changing a programme sequence

Programme sequences can be changed after the START button has been pressed. It is also possible to select a follow-on drying programme any time up to the end of a washing programme.

To change a programme which has been locked

See section "Safety lock".

To cancel a programme

- Turn both programme selectors to the *Finish* position.

The programme sequence indicators will flash one after the other in the programme sequence display. The programme has been successfully cancelled when only the *On* indicator lamp is on.

To cancel an incorrectly selected programme

- Turn both programme selectors to the *Finish* position.

When only the *On* indicator lamp is on:

- Turn the programme selector to the required programme.
- Switch additional options on or off as required.
- Press the START button.

Safety lock

Electronic programme locking (the *Locked* indicator lamp is on) prevents the door from being opened or the programme cancelled during a programme.

- The *Anti-crease/Finish* lamp flashes to show that an attempt has been made to alter a programme. This has no effect on the programme sequence.
- The locking function is switched off at the end of the programme, during "Rinse hold" and after the appliance has been switched off.

Engaging the safety lock

- Select a programme.
- Press the START button until the *Locked* indicator lamp comes on.
- The safety lock has been activated.
- The machine will not accept any changes to the programme and the programme will proceed to the end.

To de-activate the safety lock

- Press the START button until the *Locked* indicator lamp goes out.
- Or, if the *Anti-crease / Finish* indicator is flashing:
- Select the programme originally selected, and press the START button until the *Locked* indicator lamp goes out.

Cleaning and care

 Disconnect the machine from the electricity supply by switching off at the wall socket and withdrawing the plug before any cleaning and maintenance work.

Cleaning the machine

- Clean the casing with a mild non-abrasive cleaning agent or with soap and water. Wipe dry with a soft cloth.
- Clean the drum with a suitable proprietary cleaner for stainless steel.

E-Cloth

A microfibre "E-Cloth" is available from the Miele UK Spare Parts Department, Part Number 98013530, which is suitable for cleaning surfaces such as stainless steel, glass, plastic and chrome without the use of chemicals.

 Do not use solvents, abrasive cleaners, glass cleaners or all-purpose cleaners. These could damage plastic surfaces and other parts. Do not use a hose to wash the machine down.

Cleaning the detergent dispenser

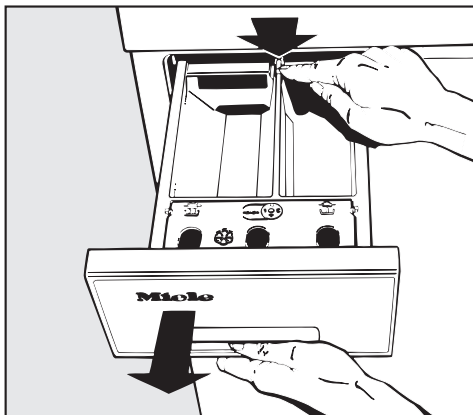

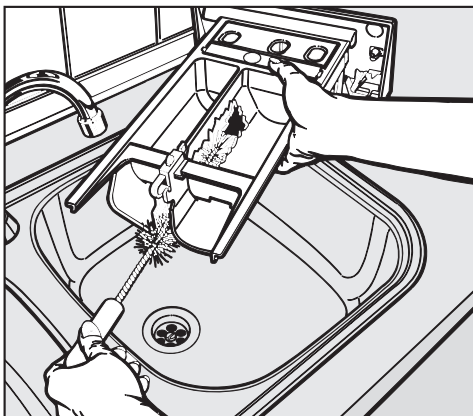

- Pull out the detergent dispenser drawer until a resistance is felt. Press down the red release catch and at the same time pull the drawer right out of the machine.

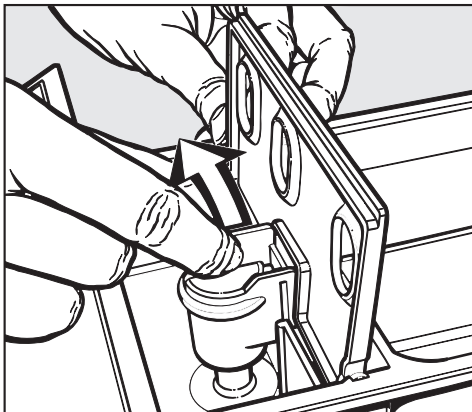

- Clean the detergent dispenser compartments and the fabric conditioner compartment with warm water.



■ Clean the siphon tube.

1. Remove the siphon from compartment  and rinse under warm running water. The channel in compartment  should also be cleaned.
2. Replace the siphon securely.

Over time, detergent residue can build up in the water jets in the top of the detergent drawer housing.

- Before replacing the detergent drawer, use a bottle brush or similar to clean them out.

Cleaning and care

Cleaning the fluff filter and pump

Check the fluff filter: initially after 3 -4 washes to ascertain how often it is likely to require cleaning.

With normal cleaning, approx. 2 litres of water run out.

However, if the drain outlet is blocked, more water will be retained in the machine (**max. 25 l litres**).

⚠ Caution: If laundry has been washed at a high temperature, water draining out of the machine will still be hot. Danger of scalding or burning!

There is a yellow filter flap opener behind the detergent drawer fascia panel.

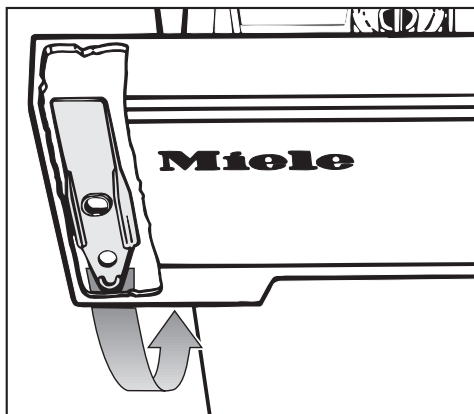

- Remove the opener.

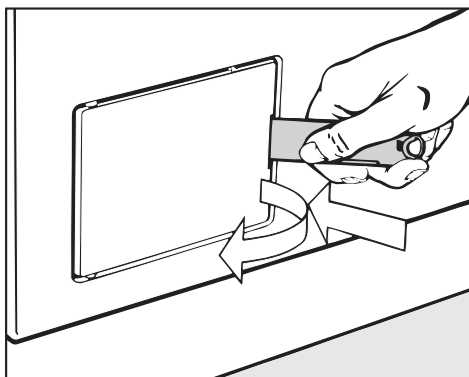

- Use it to open the access flap.

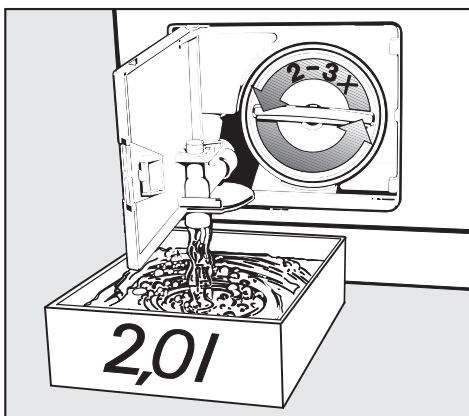

- Place a suitable container (2 litres) underneath the drain fixture.
- Turn the fluff filter lid round 2-3 times. Do **not** take it right out. Approx. 2 litres of water will drain out.

To interrupt the procedure:
Tighten the fluff filter back up again.

With large volumes of water the dish will need to be emptied several times.

Once the flow of water ceases:

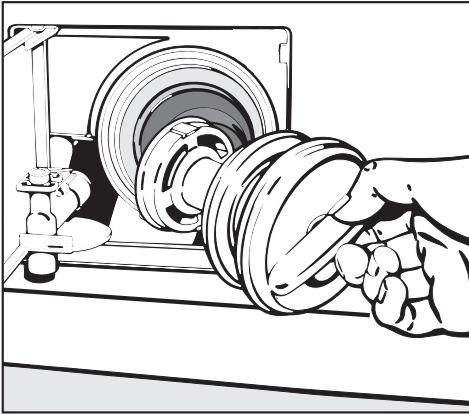

- Remove the fluff filter completely.
- Clean the fluff filter thoroughly.

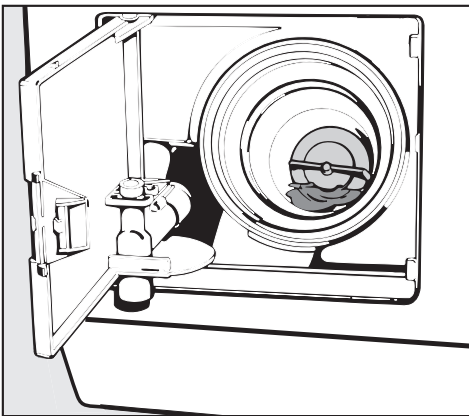

- Check the impeller by hand to make sure it rotates correctly. Remove any foreign objects (e.g. buttons, coins, etc) causing an obstruction and clean the inside of the filter housing.
- Clean the threaded union in the housing and on the filter itself.

Remove any deposits of limescale and detergent or foreign objects from the thread of the filter housing and filter unit (as these can cause a leakage of water).

- Put the fluff filter back in place and secure.

 Make sure the fluff filter is securely tightened. Otherwise there is a risk of water leakage during use.

Clean the porthole glass.

- From time to time you should also clean ...
 - the door glass on the inside using a mild detergent or soap and water.
 - the metal cap inside the door glass with a suitable proprietary stainless steel cleaning agent.
- Wipe dry using a soft cloth.

Cleaning and care

Cleaning the filter in the water inlet

The machine has a filter to protect the water inlet valve.

The filter in the open end of the inlet hose should be checked and cleaned approx. every 6 months. It should also be checked after an interruption to the external water supply.

- First turn off the stopcock.
- Unscrew the threaded union connecting the free end of the inlet hose to the stopcock.

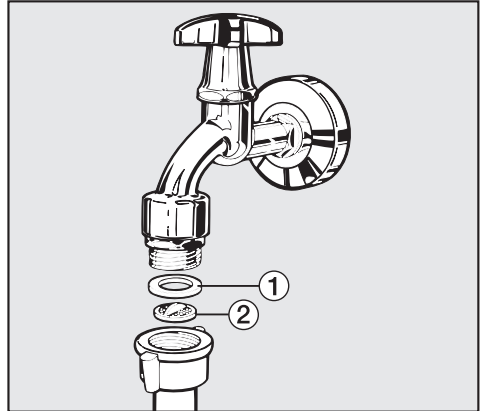

- Remove the rubber seal from the recess.
- Using pointed pliers, take hold of the plastic filter bar and remove.
- Clean the plastic filter.

Put the filter and seal back in the reverse order and reconnect the hose.

- Make sure it goes on correctly and is not cross-threaded.
- Turn on the stopcock and check that the connection is watertight. If water drips out, tighten the connection.

Never forget to put the filter back in place after cleaning.

What to do if ... ?

With the aid of the following guide, minor problems can be easily corrected without calling in a Miele service technician, saving you both time and money.

The following charts are designed to help you establish the cause of a fault or problem, and rectify it. Please note the following:

 Repair work to electrical appliances should only be carried out by a suitably qualified person in accordance with local and national safety regulations. Repairs and other work by unqualified persons could be dangerous. The manufacturer cannot be held responsible for unauthorised work.

The chart is divided into the following sections to help you:

The programme does not start.

The programme stops and a fault indicator lamp comes on.

A fault indicator lamp comes on but the wash programme continues as normal.

General problems or an unsatisfactory wash or drying result.

Problem solving guide

The programme does not start.

Problem	Possible cause	Remedy
The <i>On</i> indicator lamp does not light up in the programme sequence display or the START button indicator lamp does not flash.	There is no power to the machine.	Check whether <ul style="list-style-type: none">– the door is properly closed.– the mains plug is plugged in.– the mains fuse has blown.
If one of the following indicator lamps is flashing <ul style="list-style-type: none">- <i>Soak/Pre-wash</i>- <i>Washing</i>- <i>Rinses</i>	There is a fault.	Start the programme again. If the indicator light flashes again, call the Miele Service Dept.
The "Locked" indicator lamp is on.	The safety lock is activated.	De-activate the safety lock as described in the section "Safety lock".

The programme stops and a fault indicator lamp comes on.

Problem	Possible cause	Remedy
The <i>Water inlet/drain</i> indicator lamp is flashing and the laundry has not been washed.	The water inlet system is blocked.	<ul style="list-style-type: none">– Turn both programme selectors to the <i>Finish</i> position.– Open the stopcock.– Start the programme again.
The <i>Final spin</i> indicator lamp flashes in the programme sequence display.	The final spin was not carried out. The machine detected an imbalance.	<ul style="list-style-type: none">– Loosen the laundry load.– Turn the WASHING programme selector to <i>Spin</i>.– Make sure you select an appropriate spin speed for the laundry.

Problem solving guide

A fault indicator lamp comes on but the wash programme continues as normal.

Problem	Possible cause	Remedy
The <i>Water inlet/drain</i> indicator lamp flashes during a programme, but the wash programme has run normally.	There is a blockage in the water inlet.	Check whether: <ul style="list-style-type: none"> – the stopcock is opened wide enough. – the inlet hose is kinked.
	The water pressure is too low.	– In this case, call the Miele Service Dept.
	The filter in the water inlet hose is dirty.	– Clean the filter as described in "Cleaning and care".
The <i>Water inlet/drain</i> indicator lamp is flashing.	There is a blockage in the water outlet.	<ul style="list-style-type: none"> – Clean the fluff filter and the drain pump. – Has the drain hose been fitted too high? Max. delivery head, 1.00 m
The <i>Drying overload</i> indicator lamp is flashing towards the end of a drying programme.	The load was too large.	<ul style="list-style-type: none"> – In future do not exceed the maximum load. This way you will avoid: <ul style="list-style-type: none"> a) Creasing of delicate textiles b) Uneven drying results / damp laundry Complete the drying process using a TIMED DRYING programme.
The <i>Anti crease/Finish</i> indicator lamp is flashing and the <i>locked</i> indicator lamp is on.	The selected programme was altered with the safety lock activated.	See section "Safety Lock".

General problems or an unsatisfactory wash or drying result.

Problem	Possible cause	Remedy
The door cannot be opened.	The machine is not connected to the electricity supply.	Insert the plug in the socket.
	Power cut.	Open the door as described at the end of this section.
	The door was not correctly closed.	Press hard against the left hand side of the door and press the <i>Door</i> button.
	There is still water in the drum.	<ul style="list-style-type: none"> – Turn the WASHING programme selector to <i>Drain</i>. The water will be drained away. – Open the door.
The door cannot be opened and when the <i>Door</i> button is pressed the <i>locked</i> indicator lamp flashes.	This is not a fault. The temperature "locking" function is activated.	For safety reasons the door cannot be opened when the internal temperature is above 70°C.



Problem solving guide

Problem	Possible cause	Remedy
<p>The door cannot be opened during or after drying.</p>	<p>For safety reasons the door cannot be opened when the internal temperature is above 70°C.</p>	<p>Option 1 Wait until the temperature has dropped below 70°C and then open the door.</p>
		<p>Option 2 Select the cooling down phase*: <ul style="list-style-type: none"> – Turn the DRYING programme selector to the <i>Finish position</i>. – Turn the DRYING programme selector <u>immediately</u> to a programme: the <i>Cooling down</i> indicator lamp will light up and the cooling down phase has been selected. – At the end of the cooling down phase (the <i>Anti crease/ Finish</i> light comes on), you can open the door. <p>* If the drying programme has already finished, first start a new drying programme for a few minutes.</p> </p>
		<p>Option 3 Activate the programmable function "Opening the door at high temperatures".</p>

Problem solving guide

Problem	Possible cause	Remedy
<p>The laundry is still damp after a drying cycle.</p>	<p>The load weighed less than 1 kg. The moisture sensing system cannot operate with too small a load.</p>	<p>In future dry small loads in a TIMED DRYING programme.</p>
	<p>When washing and drying in one continuous sequence: during the spin the laundry formed a ring in the drum because the laundry was distributed unevenly.</p> <p>When drying separately: during the Thermospin the laundry formed a ring in the drum because the laundry was too damp or because the spin was set too high.</p>	<ul style="list-style-type: none"> – Turn the WASHING and DRYING programme selectors to the <i>Finish</i> position. – Open the door and loosen the laundry. – Select a lower spin speed. – Start the drying programme again.
<p>There is still water in the drum after drying.</p>	<p>There is a blockage in the water outlet.</p>	<p>Clean the fluff filter and the drain pump as described in "Cleaning and care".</p>

Problem solving guide

Problem	Possible cause	Remedy
The laundry is not spun satisfactorily.	The spin speed selected was too low.	Select a higher spin speed for the next wash programme.
	The machine was not able to distribute the laundry load evenly. Laundry was spun at a reduced spin speed to protect the machine.	Always mix large and small items in a load to avoid imbalance.
	The fluff filter is clogged.	Clean the fluff filter.
The machine is not steady during a spin cycle.	The machine feet are not level.	Level the machine (see "Installation").
In spite of adequate water pressure, the water flows into the machine too slowly.	The filter in the water inlet hose is dirty	Clean the filter.
Large amounts of detergent residue remain in the detergent dispenser drawer.	The water pressure is too low.	<ul style="list-style-type: none"> – Clean the filter in the water inlet. – Press the <i>Water plus</i> button.
	Powder detergent used in conjunction with water softeners tends to become sticky.	In future, add washing powder into the dispenser first, and then add the water softener.
Fabric conditioner is not completely dispensed or too much water remains in the  compartment.	The detergent dispenser drawer was opened or was not pushed right in whilst conditioner was being flushed in.	
	The siphon tube is not correctly positioned, or is clogged up.	<ul style="list-style-type: none"> – Clean the siphon tube. – Also clean the channel in compartment .

Problem solving guide

Problem	Possible cause	Remedy
There is an excessive build-up of foam.	Too much detergent was used.	<ul style="list-style-type: none">– Follow the manufacturer's instructions on dosage given on the packaging.– Take the water hardness level into account.– Use less detergent for lightly soiled or small loads.
White residues which look like powder detergent are seen on dark textiles after washing.	The detergent contained compounds (zeolites) to aid water softening where are not soluble in water. They have ended up on the textiles.	<ul style="list-style-type: none">– Try and brush out the residues after drying using a soft brush.– Wash dark textiles using a detergent which contains no zeolites. Liquid detergents usually contain no zeolites.
Grey, greasy particles cling to washed laundry.	Insufficient amounts of detergent have been used to break down the particles of grease in heavily soiled laundry.	<ul style="list-style-type: none">– Use more detergent.– Before washing the next load run a COTTONS 95°C programme with powder detergent but without a load.

Problem solving guide

Problem	Possible cause	Remedy
<p>Liquid detergent does not give the required result.</p>	<p>Liquid detergents usually contain no bleaching agents. They do not remove fruit, coffee and tea stains.</p>	<ul style="list-style-type: none"> – Use a general purpose detergent containing a bleaching agent. – Pour stain removers into compartment III and liquid detergent into a dispensing ball (Remember to remove the dispensing ball before drying!). – Never put stain removers and liquid detergent together in the dispenser drawer.
<p>Limescale deposits appear on the drum surface.</p>	<p>Not enough detergent was used.</p>	<ul style="list-style-type: none"> – Use a descaling agent, suitable for use in washing machines, to remove the limescale deposits. – Use the correct amount of detergent for the water hardness level.
<p>The pump makes strange noises.</p>	<p>This is not a fault! These noises occur at the end of a pump sequence as a normal part of the operation.</p>	

Opening the drum door in the event of a power failure

- Switch the machine off.

There is a yellow filter flap opener behind the detergent drawer fascia panel.

- Remove the opener.

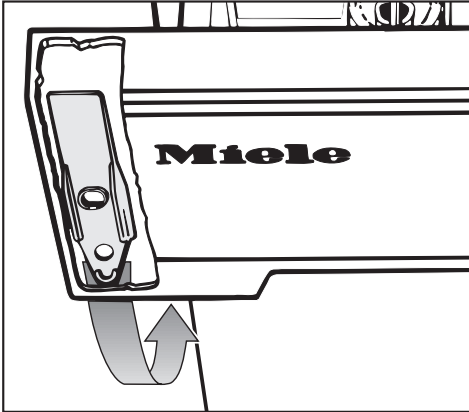

- Use it to open the access panel to the fluff filter and drain pump and drain the water as described in the "Cleaning the fluff filter and pump" section of "Cleaning and care".

⚠ Always make sure that the drum is stationary before reaching into the machine to remove laundry. Reaching into a moving drum is extremely dangerous.

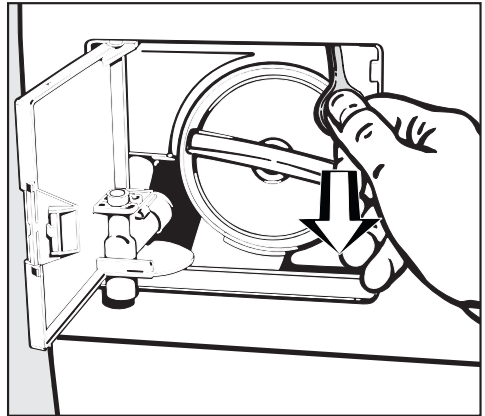

- Pull the emergency release downwards (see illustration). The drum door will open.

Problem solving guide

After sales service

In the event of any faults which you cannot remedy yourself, please contact

- Your Miele Dealer or
- The Miele Service Department (see address on back cover).

When contacting the Service Department, please quote the model and serial number of your appliance, both of which are shown on the data plate.

 Please note that telephone calls may be monitored and recorded to improve our service.

Appliance guarantee

The appliance is guaranteed for a period of 1 year.

See the guarantee card supplied with the appliance for further details.

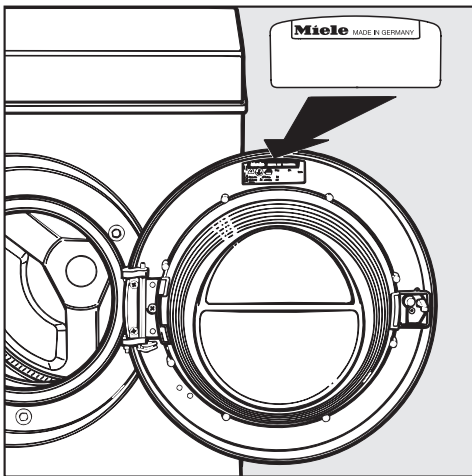

Front view

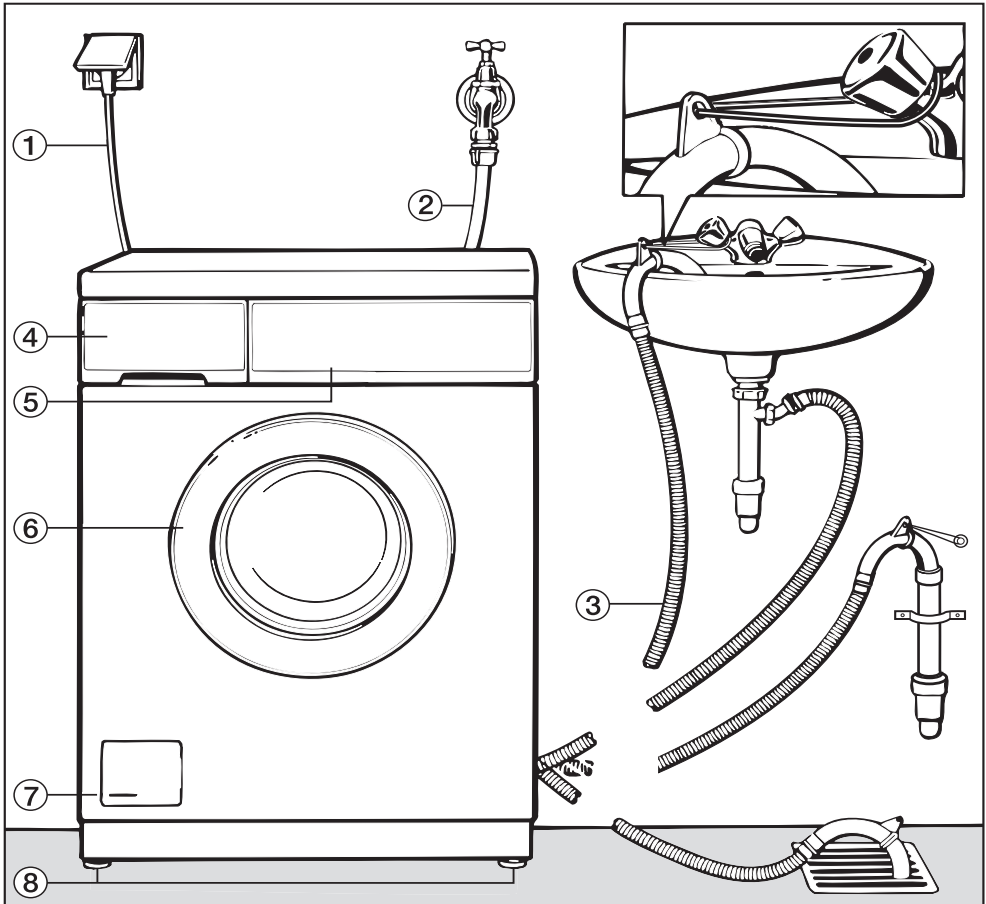

- ① Electrical connection
- ② Inlet hose
- ③ Drain hose with flexible / detachable swivel elbow
- ④ Detergent dispenser
- ⑤ Control panel
- ⑥ Door
- ⑦ Flap for fluff filter and drain pump
- ⑧ Four height adjustable screw feet

Installation and connection

Installation surface

A concrete floor is the most suitable installation surface. It is far less prone to vibration during the spin cycle than wooden floorboards or a carpeted surface.

Please note the following:

- The machine must be level and securely positioned.
- To avoid vibrations during spinning the machine should not be installed on soft floor coverings.

If installing on a wooden joist floor:

- We recommend the use of a plywood base at least 59x52x3 cm. The base should span several joists and be bolted to the joists and not only to the floorboards. Check for pipes and cables beforehand!

The most stable part of the floor is usually in the corner.

 If the machine is installed on a raised plinth, it **has** to be secured against slippage during spin using retaining clips (available from the Miele Spare Parts Dept). Otherwise there is the danger of the machine moving about.

Installation

Lift the machine from its packaging base and move it to its site. Please note the following:

- Do not lift the machine by the drum door.

 Ensure that the machine feet and the floor area are dry to prevent the machine from slipping during the spin cycle.

Removing the transit fitting

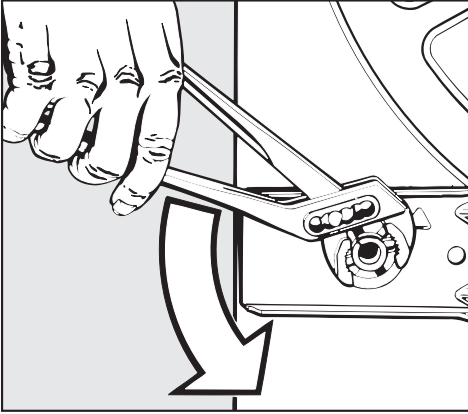

- ❶ Turn the left-hand transit bar 90°.

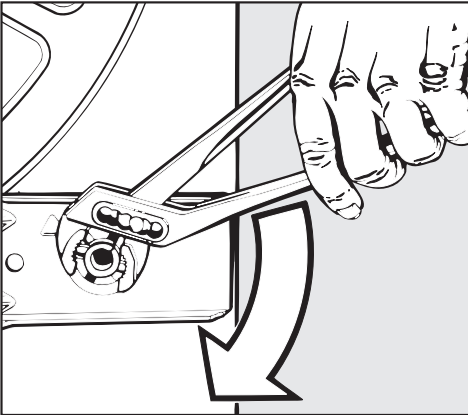

- ❷ Turn the right-hand transit bar 90°.

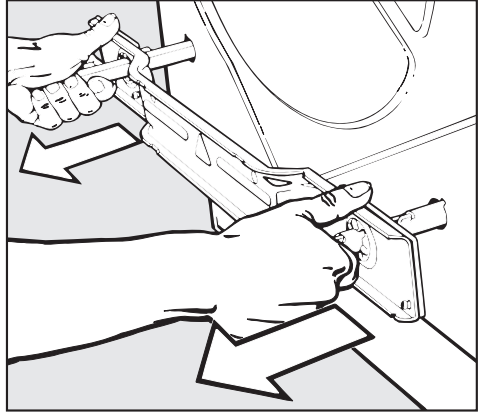

- ❸ Withdraw the two bars together with the support plate.

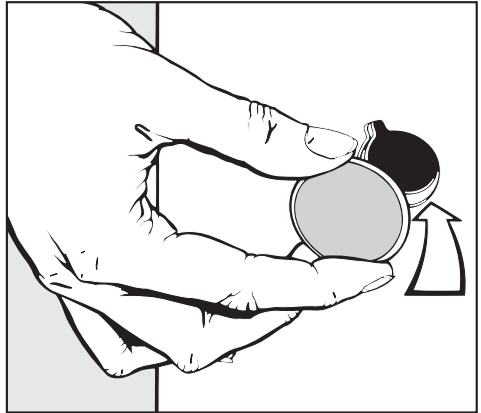

- ❹ Plug the holes with the plastic caps supplied.

The machine must not be moved without the transit fitting in place. Store the transit fitting in a safe place for future use. It must be re-fitted if the machine is to be moved again (e.g. when moving house).

Re-fitting is carried out by reversing the procedure.

Installation and connection

Levelling the machine

The machine must stand perfectly level on all four feet to ensure safe and proper operation.

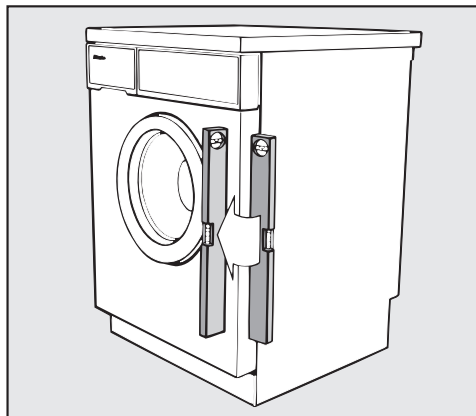

Incorrect installation may increase electricity and water consumption and may cause the machine to move about.

The four adjustable feet are used to level the machine. All four feet are screwed in when the machine is delivered.

Screwing out and adjusting the feet

- Gently tip the machine and prop it up using a solid wooden wedge for example, to ensure stability.

 Make sure the machine does not slip as this could cause injury.

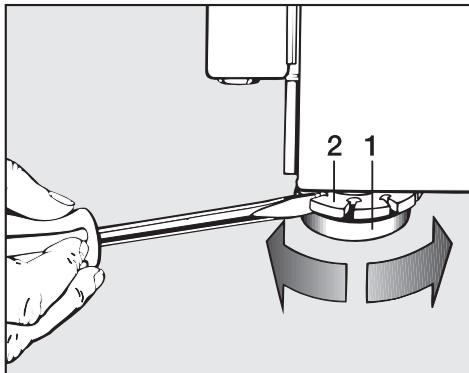

- Loosen counternut **2** with a screwdriver by turning it anti-clockwise, then unscrew foot **1** together with the counternut.
- Put the machine back on all four feet.
- Use a spirit level to check the machine is standing level.
- Hold the foot **1** firm using a pipe wrench and using a screwdriver turn the counternut **2** to the right firmly up against the housing.

 All four counternuts must be firmly up against the housing. Please also check this for the feet which did not need adjustment. Otherwise there is the danger of the machine moving about.

Building under a continuous worktop / in a row of kitchen units

The building under kit* must be fitted by a suitably qualified fitter.

- A special **building under kit*** is required. The cover plate supplied with the building under kit* replaces the machine's lid.
To ensure electrical safety the cover plate must be fitted.
- When installing under a 900/910 mm high worktop a spacer kit* is required.
- Connections for electricity, water and drainage should be installed in such a way that they remain accessible when the machine is in place.

Fitting instructions are supplied with the building under kit.

All items marked * are available to order from your Miele Dealer or from the Miele Spare Parts Dept.

Installation and connection

Connection to the water supply

The machine should be connected to the water supply in accordance with standard regulations. The German authorities do not require it to have a non-return valve as the washer-dryer has been constructed to comply with the relevant valid standard (DIN-Norm).

Connection to the water supply should be carried out by a qualified plumber and should incorporate a stopcock with a 3/4" thread. The stopcock should be fitted by a qualified plumber.

The approx. 1.5 m long 3/8" pressure hose should be connected to the stopcock via the 3/4" threaded union.

This hose is **not** suitable for connection to a hot water supply. Make sure that the washer sits correctly in the union.

The connection points are subject to water pressure. Turn on the stopcock slowly and check for leaks.

If replacing the inlet hose only use a hose tested to withstand pressure of at least 70 bar. This also applies to all fittings used. Miele original hose kits are tested to this standard.

Longer hoses, 2.5 and 4.0 m in length are available as optional extras.

The machine is designed to operate with a flow pressure of between 1 and 10 bar. If it is higher than 10 bar it is essential to fit a reducer valve.

There is a minimum flow pressure of 1 bar if 5 litres of water flow into a suitable container in 15 seconds.

The two dirt filters - one in the open end of the inlet hose, one at the inlet point in the solenoid valve must not be removed.

Connection to the drainage system

The machine drains via a drain pump with a delivery head of 1 metre. The drain hose is 1.5 m long. It must not be kinked as this restricts drainage. The swivel elbow at the end of the hose can be turned in either direction, or can be detached if required, with a sharp twist and pull.

Drain hose connection:

1. Direct into a sink.

Please note the following

- Hook the hose over the edge and secure.
 - Make sure that the water can drain away freely without hindrance. Otherwise there is a risk of water overflowing or of some of the drained water being sucked back into the machine.
2. Connected securely to a plastic drain pipe with a rubber nipple. There is no need to use a non-return valve.
 3. Connected securely to a standpipe.
 4. Connected securely to a floor gully.

If required the drain hose can be extended to a length of 5 metres. The accessories required can be purchased from the Miele Spare Parts Dept.

For draining the water away with a delivery head over 1 metre (and up to a max. of 1.8 metres) a 2nd "Duo-drain pump" is available together with the corresponding kit from your Miele Dealer or the Miele Spare Parts Dept.

Installation and connection

Electrical connection U.K.

All electrical work should be carried out only by a suitably qualified and competent person, in strict accordance with national and local safety regulations.

Ensure power is not supplied to the appliance while installation work is being carried out.

The appliance is supplied with a mains cable with moulded plug for connection to a 230-240V mains supply. **The voltage, rated load and fuse rating are given on the data plate.** Please ensure these match the household mains supply.

Connection should be made via a fused plug and suitable switched socket which is easily accessible after installation.

For extra safety it is advisable to install a residual current device (RCD), with a trip current of 30 mA (in accordance with DIN VDE 0664, VDE 0100, section 739).

Do not connect via an extension lead.

Important

The wires in the mains lead are coloured in accordance with the following code:

Green/yellow = earth

Blue = neutral

Brown = live

Electrical connection U.K. Non-rewireable plugs BS 1363

If this machine is fitted with a non-rewireable plug and the socket outlets are not suitable for the plug supplied or if the existing plug needs to be replaced by a new one, the old plug will need to be cut off and an appropriate plug fitted. The fuse carrier and the fuse should be removed from the old plug and disposed of.

The plug cut from the cable should then be disposed of and on no account be inserted into any socket elsewhere in the house (electric shock hazard).

The fuse cover must be refitted when changing the fuse, and if the fuse cover is lost, the plug must not be used until a suitable replacement is obtained. The colour of the correct replacement cover is that of the coloured insert in the base of the plug, or the colour that is embossed in words on the base of the plug (as applicable to the design of plug fitted).

Replacement fuses should be ASTA approved to BS 1362 and have the correct rating. Replacement fuse covers may be purchased from your local electrical supplier or Service agent.

If the colours of the wires in the mains lead of this appliance do not correspond with the coloured markings identifying the terminals of your plug, proceed as follows:

- The wire which is coloured green and yellow must be connected to the terminal in the plug which is marked with the letter E or by the earth symbol \perp or coloured green, or green and yellow.
- The wire which is coloured blue must be connected to the terminal in the plug which is marked with the letter N or coloured black.
- The wire which is coloured brown must be connected to the terminal in the plug which is marked with the letter L or coloured red.

**WARNING: THIS APPLIANCE
MUST BE EARTHED**

Consumption data

Programmes	Full load kg	Energy consumption kWh	Water consumption l	Programme duration h min
WASHING				
COTTONS 95°C	5.0	1.70	59	1 53
COTTONS 60°C ⁽¹⁾	5.0	0.95	56	1 56
COTTONS 40°C	5.0	0.50	56	1 56
MINIMUM IRON 40°C	2.0	0.45	57	1 20
DELICATES 30°C	1.0	0.40	75	1 00
WOOLLENS 30°C	1.0	0.15	25	0 38
WASHING and DRYING				
COTTONS 60°C and COTTONS Normal ⁽²⁾	5.0	3.85	78	4 10
COTTONS 60°C and COTTONS Normal	2.5	2.40	47	2 40
DRYING				
COTTONS Normal ⁽³⁾	2.5	1.45	9	1 03

1) EN 60456 test programme

2) EN 50229 test programme

3) EN 61121 test programme

Consumption data can vary from the nominal values given depending on water pressure, water hardness, water inlet temperature, room temperature, type and volume of load, fluctuations in the electricity supply and any additional options selected.

Technical data

Height	85.0 cm
Width	59.5 cm
Depth with lid fitted	60.0 cm
Depth without lid	57.5 cm
Weight, empty	98 kg
Max. floor load	1600 Newton (approx. 160 kg)
Capacity – Washing Capacity – Drying	max. 5.0 kg dry laundry max. 2.5 kg Cottons
Voltage	see data plate
Rated load	see data plate
Fuse rating	see data plate
Consumption data	see "Consumption data" section
Minimum water flow pressure	1 bar (100 kPa)
Maximum water flow pressure	10 bar (1000 kPa)
Maximum drain pump head	1.00 m
Maximum drain pump length	5.00 m
Test marks	VDE, radio and television suppressed

Programmable functions for changing standard settings

Programmable functions

The programmable functions can be used to tailor programmes to suit your individual requirements. Once activated the programmable functions remain in memory until they are deactivated.

High water level

This is useful where a higher quality rinse is required.

It is available for the rinses in the following wash programmes:

- COTTONS
- MINIMUM IRON
- QUICK WASH 40°C

Follow steps ❶ to ❷ to programme and store in memory.

The programmable functions are activated with the help of the additional option buttons and the WASHING programme selector.

Before you begin, first ensure that:

- the machine is switched off.
- the drum door is closed.
- the WASHING and DRYING programme selectors are at the *Finish* position.

❶ Press the additional option buttons *Soak* and *Pre-wash* at the same time, hold pressed in and . .

❷ . . . switch the machine on with the *I-ON / 0-OFF* button.

❸ Then release these buttons.

– The *Soak/Pre-wash* and *Washing* sequence indicator lamps will flash.

– A *P* will appear in the left of the display.

❹ Turn the WASHING programme selector to the *Rinse out fluff* position.

❺ The following will appear in the display:

0 = Programmable function off (de-activated)

or

1 = Programmable function on (active)

Press the START button to switch between

0 to *1* activated or from

1 to *0* deactivated.

❻ Switch the machine off with the *I-ON / 0-OFF* button.

The setting you have selected is now stored in memory.

❼ Turn the WASHING programme selector to the *Finish* position.

Additional rinse for the COTTONS programme

Suitable for areas with soft water (hardness range I).

If a particularly good rinsing effect is required in an area with soft water, then the high water level can be activated in addition to the additional rinse.

Follow steps ❶ to ❷ to programme and store in memory.

The programmable functions are activated with the help of the additional option buttons and the WASHING programme selector.

Before you begin, first ensure that:

- the machine is switched off.
- the drum door is closed.
- the WASHING and DRYING programme selectors are at the *Finish* position.

- ❶ Press the additional option buttons *Soak* and *Pre-wash* at the same time, hold pressed in and . .
- ❷ . . . switch the machine on with the *I-ON / O-OFF* button.

❸ Then release these buttons.

- The *Soak/Pre-wash* and *Washing* sequence indicator lamps will flash.
- A *P* will appear in the left of the display.

❹ Turn the WASHING programme selector to the *Separate rinse* position.

❺ The following will appear in the display:

 = Programmable function off (de-activated)

or

I = Programmable function on (active)

Press the START button to switch between

 to *I* activated or from

I to  deactivated.

❻ Switch the machine off with the *I-ON / O-OFF* button.

The setting you have selected is now stored in memory.

❼ Turn the WASHING programme selector to the *Finish* position.

Programmable functions

Buzzer

An audible tone will sound at the end of a washing / drying programme.

The machine is delivered with this programmable function activated.

Follow steps ❶ to ❷ to programme and store in memory.

The programmable functions are activated with the help of the additional option buttons and the WASHING programme selector.

Before you begin, first ensure that:

- the machine is switched off.
- the drum door is closed.
- the WASHING and DRYING programme selectors are at the *Finish* position.

❶ Press the additional option buttons *Soak* and *Pre-wash* at the same time, hold pressed in and . . .

❷ . . . switch the machine on with the *I-ON / O-OFF* button.

❸ Then release these buttons.

– The *Soak/Pre-wash* and *Washing* sequence indicator lamps will flash.

– A *P* will appear in the left of the display.

❹ Turn the WASHING programme selector to the "COTTONS 40°C" position.

❺ The following will appear in the display:

 = Programmable function off (de-activated)

or

I = Programmable function on (active)

Press the START button to switch between

 to *I* activated or from

I to  deactivated.

❻ Switch the machine off with the *I-ON / O-OFF* button.

The setting you have selected is now stored in memory.

❼ Turn the WASHING programme selector to the *Finish* position.

Opening the door at high temperatures

It is possible to open the door during a washing or drying programme, even if the temperature is above 70°C.

 **Warning: The water in the machine will be very hot and could cause burning or scalding.**

The machine is delivered with the programmable function switched off.

Follow steps ❶ to ❷ to programme and store in memory.

The programmable functions are activated with the help of the additional option buttons and the WASHING programme selector.

Before you begin, first ensure that:

- the machine is switched off.
- the drum door is closed.
- the WASHING and DRYING programme selectors are at the *Finish* position.

❶ Press the additional option buttons *Soak* and *Pre-wash* at the same time, hold pressed in and . . .

❷ . . . switch the machine on with the *I-ON / O-OFF* button.

❸ Then release these buttons.

- The *Soak/Pre-wash* and *Washing* sequence indicator lamps will flash.
- A *P* will appear in the left of the display.

❹ Turn the WASHING programme selector to the "DELICATES Cold" position.

❺ The following will appear in the display:

 = Programmable function off (de-activated)

or

I = Programmable function on (active)

Press the START button to switch between

 to *I* activated or from

I to  deactivated.

❻ Switch the machine off with the *I-ON / O-OFF* button.

The setting you have selected is now stored in memory.

❼ Turn the WASHING programme selector to the *Finish* position.

Programmable functions

Final residual moisture after drying

The machine is set to give the best drying results. You do, however, have the option of shortening or lengthening the drying time if you prefer.

Shortening the drying time:

by:	the display will show:
1 minute	1
2 minutes	2
3 minutes	3
4 minutes	4

Lengthening the drying time:

by:	the display will show:
1 minute	5
2 minutes	6
3 minutes	7
4 minutes	8

Factory setting: 0

Follow steps ① to ⑦ to programme and store in memory.

The programmable functions are activated with the help of the additional option buttons and the WASHING programme selector.

Before you begin, first ensure that:

- the machine is switched off.
- the drum door is closed.

– the WASHING and DRYING programme selectors are at the *Finish* position.

① Press the additional option buttons *Soak* and *Pre-wash* at the same time, hold pressed in and . .

② . . . switch the machine on with the *I-ON / O-OFF* button.

③ Then release these buttons.

– The *Soak/Pre-wash* and *Washing* sequence indicator lamps will flash.

– A *P* will appear in the left of the display.

④ Turn the WASHING programme selector to MINIMUM IRON 30°C .

⑤ A number between 0 and 8 will appear in the display.

By pressing the START button repeatedly you can:

– shorten

the drying time in 1 minute steps:

1, 2, 3 or 4 will appear in the display;

– increase

the drying time in 1 minute steps, 5, 6, 7 or 8 will appear in the display;

– or accept the factory setting (0 will appear in the display).

⑥ Switch the machine off with the *I-ON / O-OFF* button.

The setting you have selected is now stored in memory.

⑦ Turn the WASHING programme selector to the *Finish* position.

**United Kingdom:**

Miele Co. Ltd.
Fairacres, Marcham Road
Abingdon, Oxon, OX14 1TW
tel. Abingdon (01235) 554455
Service Office: (01235) 554466
fax (01235) 554477
Internet: www.miele.co.uk

Ireland:

Miele Ireland Ltd.
Broomhill Road, Tallaght, Dublin 24
Tel: (01) 46 10 710, Fax: (01) 46 10 797
Email: info@miele.ie
Internet: <http://www.miele.ie>

Australia:

Miele Australia Pty. Ltd.
A.C.N. 005635398
1 Gilbert Park Drive
Knoxfield, VIC 3180
Telephone: (03) 9764 7100
Fax: (03) 9764 7129

Distributor New Zealand:

Steelfort Engineering Company. Ltd.
500 Rangitikei Street
Palmerston North, Priv. Bag 11045, NZ
Telephone: (06) 350 1350
Fax: (06) 356 1507

South Africa:

Miele (Pty) Ltd
304 Tungsten Road
Strijdom Park 2194
P.O.Box 1654, Randburg 2125
Tel. (011) 793-7452
Telefax (011) 793-7447
E-mail: info@miele.co.za
Internet: www.miele.co.za

Singapore:

Miele Southeast Asia
Miele Pte. Ltd.
163 Penang Road
04 - 02/03 Winsland House II
Singapore 238463
Tel : +65-67351161
Fax: +65-67351191
Email: mielesea@miele.com.sg

Hong Kong:

Miele (Hong Kong) Limited
AIA Plaza, Room 401, 4th Floor
18 Hysan Avenue
Causeway Bay
Hong Kong
Tel.: (852) 2610 1331
Fax: (852) 2610 1013
E-mail: mielehk@netvigator.com